

---

# Front-Panel Operation Reference

## Volume 2 of 2

**HP 1652B/HP 1653B  
Logic Analyzers**

---



©Copyright Hewlett-Packard Company 1989

Manual Set Part Number 01652-90902

Printed in the U.S.A. November 1989



## Contents Volume 2

---

<b>Chapter 16:</b>	<b>The Timing Analyzer</b>	
	Introduction .....	16-1
	The Timing Analyzer (An Overview) .....	16-1
	Timing Analyzer Menu Maps .....	16-1
	Timing Format Menu Map .....	16-2
	Timing Trace Menu Map .....	16-3
	Timing Waveform Menu Map .....	16-4

---

<b>Chapter 17:</b>	<b>Timing Format Specification Menu</b>	
	Introduction .....	17-1
	Accessing the Timing Format Specification Menu .....	17-1
	Timing Format Specification Menu .....	17-1
	Timing Format Specification Menu Fields .....	17-3
	Label .....	17-3
	Turn Label On .....	17-3
	Modify Label .....	17-4
	Turn Label Off .....	17-4
	Polarity (Pol) .....	17-4
	Bit Assignment .....	17-4
	Pod Threshold .....	17-6
	Specify Symbols Menu .....	17-7
	Specify Symbols Menu Fields .....	17-8
	Label .....	17-8
	Base .....	17-8
	Symbol View Size .....	17-10
	Symbol Name .....	17-10
	Leaving the Symbol Table Menu .....	17-12

---

<b>Chapter 18:</b>	<b>Timing Trace Specification Menu</b>	
	Introduction .....	18-1
	Accessing the Timing Trace Specification Menu .....	18-1
	Timing Trace Specification Menu .....	18-1
	Timing Trace Specification Menu Fields .....	18-2
	Trace Mode .....	18-3
	Armed By .....	18-3

Acquisition Mode .....	18-3
Transitional Acquisition Mode .....	18-4
Glitch Acquisition Mode .....	18-5
Label .....	18-6
Base .....	18-6
Find Pattern .....	18-7
Pattern Duration (present for ____)	18-9
Then Find Edge .....	18-11

## Chapter 19:

### Timing Waveforms Menu

Introduction .....	19-1
Accessing the Timing Waveforms Menu .....	19-2
Timing Waveforms Menu Fields .....	19-3
Markers .....	19-3
Markers Time .....	19-4
Markers Patterns .....	19-5
Stop Measurement .....	19-5
Markers Statistics .....	19-6
Accumulate Mode .....	19-6
At ____ Marker .....	19-7
Time/Div (time per division) Field .....	19-8
Delay Field .....	19-9

## Chapter 20:

### Timing Analyzer Measurement Example

Introduction .....	20-1
Problem Solving with the Timing Analyzer .....	20-2
What Am I Going to Measure? .....	20-2
How Do I Configure the Logic Analyzer? .....	20-3
Connecting the Probes .....	20-5
Activity Indicators .....	20-5
Configuring the Timing Analyzer .....	20-6
Specifying a Trigger Condition .....	20-8
Acquiring the Data .....	20-9
The Timing Waveforms Menu .....	20-10
The X and O .....	20-10
The ▼ .....	20-11
The Vertical Dotted Line .....	20-11
Configuring the Display .....	20-12
Display Resolution .....	20-12

Making the Measurement .....	20-13
Finding the Answer .....	20-14
Summary .....	20-15

---

## Chapter 21:

### Timing/State Measurement Example

Introduction .....	21-1
Problem Solving with the Timing/State Analyzer .....	21-2
What Am I Going to Measure? .....	21-2
How Do I Configure the Logic Analyzer? .....	21-3
Configuring the State Analyzer .....	21-4
Connecting the Probes .....	21-5
Acquiring the Data .....	21-5
Finding the Problem .....	21-6
What Additional Measurements Must I Make? .....	21-7
How Do I Re-configure the Logic Analyzer? .....	21-8
Connecting the Timing Analyzer Probes .....	21-8
Configuring the Timing Analyzer .....	21-9
Setting the Timing Analyzer Trigger .....	21-10
Time Correlating the Data .....	21-11
Re-acquiring the Data .....	21-12
Mixed Mode Display .....	21-12
Interpreting the Display .....	21-13
Overlapping Timing Waveforms .....	21-14
Finding the Answer .....	21-15
Summary .....	21-16

---

## Chapter 22:

### The Oscilloscope

Introduction .....	22-1
The Scope (An Overview) .....	22-1
Scope Menu Maps .....	22-1
The Channel Menu Map .....	22-2
The Trigger Menu Map .....	22-3
The Waveforms Menu Map .....	22-4
Waveform Selection Menu Map .....	22-5
Specify Markers Menu Map .....	22-5
Menu Overview .....	22-6

---

**Chapter 23:****Channel Menu**

Introduction .....	23-1
Channel Menu Fields .....	23-1
Input Field .....	23-1
V/Div Field .....	23-2
Offset Field .....	23-3
Probe Field .....	23-4
Impedance Field .....	23-5
Preset Field .....	23-5
Waveform Selection .....	23-6
Waveform Selection Setup .....	23-7
Connecting the Equipment .....	23-7
Setting Up the Oscilloscope .....	23-7
Turning the Waveforms On/Off .....	23-8
Insert/Delete Waveforms .....	23-9
Modify Waveforms .....	23-10
Overlay (C1,C2) .....	23-11
Waveform Math (C1 + C2), (C1-C2) .....	23-12
Timebase Functions .....	23-13
Instrument Setup .....	23-13
s/Div Field .....	23-14
Zoom (Acquisition Stopped) .....	23-15
Zoom Example .....	23-15
Delay Field .....	23-17
Scrolling (Acquisition Stopped) .....	23-17
Scroll Example .....	23-18
Autoscale Field .....	23-19
When a Signal is Found .....	23-20
If No Signal is Found .....	23-21

---

**Chapter 24:****Trigger Menu**

Introduction .....	24-1
Calibration .....	24-1
Trigger Marker .....	24-2
Mode Field .....	24-2
Immediate Trigger Mode .....	24-3
Armed by Field .....	24-3
Run .....	24-4

BNC Input .....	24-4
Machine 1 and 2 .....	24-4
Edge Trigger Mode .....	24-4
Source Field .....	24-4
Level Field .....	24-5
Slope Field .....	24-6
Auto-Trig Field .....	24-6
On .....	24-6
Off .....	24-6
Run mode Field .....	24-7
Single Mode Run .....	24-7
Repetitive Mode Run .....	24-7

## Chapter 25:

### Waveforms Menu

Introduction .....	25-1
Scope Field .....	25-1
Auto-Measure Field .....	25-1
Top and Base Voltages .....	25-3
Automatic Measurement Example .....	25-4
Connecting the Equipment .....	25-4
Setting Up the Oscilloscope .....	25-4
Rise Time Measurement .....	25-5
Fall Time Measurement .....	25-6
Vp-p Measurement .....	25-7
Period and Frequency Measurements .....	25-8
+ Width and -Width Measurements .....	25-9
Preshoot and Overshoot Measurements .....	25-10
Marker Measurements .....	25-12
Markers Field .....	25-13
Sample Period Display .....	25-14
Time .....	25-14
X to O Field .....	25-14
Trig to X Field .....	25-15
Trig to O Field .....	25-15
Search .....	25-16
Specify Search Markers .....	25-16
Type markers .....	25-17
X-Marker set on ___ & O-Marker set on ___ .....	25-17
Stop Measurement when X-O .....	25-18
Less than .....	25-19

Greater than .....	25-20
In range ___ to ___ .....	25-21
Not in range ___ to ___ .....	25-21
Store exception to disk: .....	25-22
X-pattern ___ from start & O-pattern ___ from start .....	25-22
Statistics .....	25-23
Search Marker Measurement Example .....	25-24
Connecting the Equipment .....	25-24
Making the Measurement .....	25-24
Display Field .....	25-29
Normal Mode .....	25-29
Average Mode .....	25-30
Accumulate Mode .....	25-31
Connect Dots Field .....	25-31
Grid .....	25-31

## Chapter 26:

### Mixed Mode Displays

Introduction .....	26-1
Mixed Mode field .....	26-1
Timing/State Mixed Mode Display .....	26-2
State/State Mixed Mode Display .....	26-3
Timing/Scope Mixed Mode Display .....	26-4
Arming the Oscilloscope .....	26-4
Displaying Timing Waveforms .....	26-5
State/Timing And Scope Mixed Mode Display .....	26-8
Time-Correlated Displays .....	26-9

## Chapter 27:

### Timing/State/Oscilloscope Measurement Example

Introduction .....	27-1
Problem Solving with the Timing/State/Scope Analyzer .....	27-1
What Am I Going to Measure? .....	27-2
How Do I Configure the Logic Analyzer? .....	27-3
Configuring the State Analyzer .....	27-4
Connecting the Probes .....	27-6
Acquiring the Data .....	27-6
Finding the Problem .....	27-7
What Additional Measurements Must I Make? .....	27-8
How Do I Re-configure the Logic Analyzer? .....	27-9
Connecting the Timing Analyzer Probes .....	27-9



Configuring the Timing Analyzer .....	27-10
Setting the Timing Analyzer Trigger .....	27-11
Time Correlating the Data .....	27-12
Re-acquiring the Data .....	27-13
Mixed Mode Display .....	27-13
Interpreting the Display .....	27-14
Re-configure the Analyzer with Scope .....	27-14
Connecting the Scope Probes .....	27-15
Arming the Scope .....	27-16
Making the Scope Measurement .....	27-17
Mixed Mode Display with Scope .....	27-18
Finding the Answer .....	27-19
Summary .....	27-19

## Appendix A:

### Microprocessor Specific Measurements

Introduction .....	A-1
Microprocessor Measurements .....	A-1
Microprocessors Supported by Preprocessors .....	A-2
Z80 .....	A-3
NSC 800 .....	A-4
8085 .....	A-5
8086 or 8088 .....	A-6
80186 or 80C186 .....	A-7
80286 .....	A-8
80386 .....	A-9
6800 or 6802 .....	A-10
6809 or 6809E .....	A-11
68008 .....	A-12
68000 and 68010 (64-pin DIP) .....	A-13
68000 and 68010 (68-pin PGA) .....	A-14
68020 .....	A-15
68030 .....	A-16
68HC11 .....	A-17
Loading Inverse Assembler Files .....	A-18
Selecting the Correct File .....	A-18
Loading the Desired File .....	A-18
Connecting the Logic Analyzer Probes .....	A-19
How to Display Inverse Assembled Data .....	A-19

---

**Appendix B:****Automatic Measurement Algorithms**

Introduction .....	B-1
Measurement Setup .....	B-1
Making Measurements .....	B-1
Top and Base Voltages .....	B-2
Measurement Algorithms .....	B-3
Frequency (Freq) .....	B-3
Period .....	B-3
Peak-to-Peak Voltage (Vp_p) .....	B-3
Positive Pulse width (+ Width) .....	B-4
Negative Pulse width (-Width) .....	B-4
Risetime .....	B-4
Falltime .....	B-4
Preshoot and Overshoot .....	B-5
Duty Cycle .....	B-6
rms Voltage .....	B-6
Average Voltage .....	B-6

---

**Appendix C:****Error Messages**

Introduction .....	C-1
--------------------	-----

---

**Appendix D:****Installation, Maintenance and Calibration**

Introduction .....	D-1
Initial Inspection .....	D-1
Operating Environment .....	D-2
Ventilation .....	D-2
Storage and Shipping .....	D-2
Tagging for Service .....	D-2
Original Packaging .....	D-2
Other Packaging .....	D-3
Power Requirements .....	D-3
Power Cable .....	D-4
Removing Yellow Shipping Disc .....	D-6
Selecting the Line Voltage .....	D-7
Checking for the Correct Fuse .....	D-8
Applying Power .....	D-8
Loading the Operating System .....	D-8

Installing the Operating System Disc .....	D-9
Line Switch .....	D-10
Intensity Control .....	D-10
Operator's Maintenance .....	D-11
Calibration .....	D-11
Calibration Interval .....	D-11
Calibration Integrity .....	D-11
Software Calibration Procedures .....	D-12
Offset Calibration .....	D-12
Attenuator Calibration .....	D-13
Gain Calibration .....	D-14
Trigger Calibration .....	D-14
Delay Calibration .....	D-15

---

## Appendix E:

### Operator Self Tests

Introduction .....	E-1
Self Tests .....	E-1
Power-up Self Test .....	E-1
Selectable Self Tests .....	E-2

---

## Appendix F:

### Specifications and Operating Characteristics

Introduction .....	F-1
Logic Analyzer Specifications .....	F-1
Probes .....	F-1
State Mode .....	F-1
Timing Mode .....	F-2
Logic Analyzer Operating Characteristics .....	F-2
Probes .....	F-2
Measurement Configurations .....	F-3
State Analysis .....	F-3
Memory .....	F-3
Trace Specification .....	F-3
Tagging .....	F-4
Symbols .....	F-5
State Compare Mode .....	F-5
State X-T Chart .....	F-6
State Waveform .....	F-6
Timing Analysis .....	F-7
Transitional Timing Mode .....	F-7

Glitch Capture Mode .....	F-7
Waveform Display .....	F-7
Time Interval Accuracy .....	F-8
Trigger Specification .....	F-8
Measurement and Display Functions .....	F-8
Autoscale (Timing Analyzer Only) .....	F-8
Acquisition Specifications .....	F-8
Labels .....	F-9
Indicators .....	F-9
Marker Functions .....	F-9
Run/Stop Functions .....	F-10
Data Display/Entry .....	F-10
Oscilloscope Specifications .....	F-11
Vertical (at BNC) .....	F-11
Horizontal .....	F-11
Trigger .....	F-11
Oscilloscope Operating Characteristics .....	F-11
Vertical .....	F-11
Horizontal .....	F-13
Trigger .....	F-13
Waveform Display .....	F-14
Measurement Aids .....	F-15
Setup Aids .....	F-15
Interactive Measurements .....	F-16
Acquisition .....	F-16
Mixed Display .....	F-16
Time Correlation .....	F-16
Time Interval Accuracy Between Modules .....	F-16
General Characteristics .....	F-17
Operating Environment .....	F-17
Power Requirements .....	F-18
Weight .....	F-18
Dimensions .....	F-18

---

## Index

## The Timing Analyzer

---

### Introduction

This chapter introduces the timing analyzer and contains the timing analyzer menu maps.

Chapters 17 through 19 explain each of the Timing Analyzer menus as follows:

- Chapter 17 explains the Timing Format Menu.
- Chapter 18 explains the Timing Trace Menu.
- Chapter 19 explains the Timing Waveforms Menu.
- Chapter 20 gives you a basic Timing Analyzer Measurement example.
- Chapter 21 gives you a basic Timing/State Analyzer Measurement example.

---

### The Timing Analyzer (An Overview)

The timing analyzer acquires data asynchronously using an internal sample clock. This asynchronous data acquisition technique is similar to a digitizing oscilloscope. The acquired data is displayed in the form of one or more waveforms. The timing waveforms differ from a digitizing oscilloscope in that the timing analyzer only stores and displays two levels (one above and one below threshold).

---

### Timing Analyzer Menu Maps

The Timing Analyzer menu maps show you the fields and the available options of each field within the three menus. The menu maps will help you get an overview of each menu as well as provide you with a quick reference of what each menu contains.

# Timing Format Menu Map

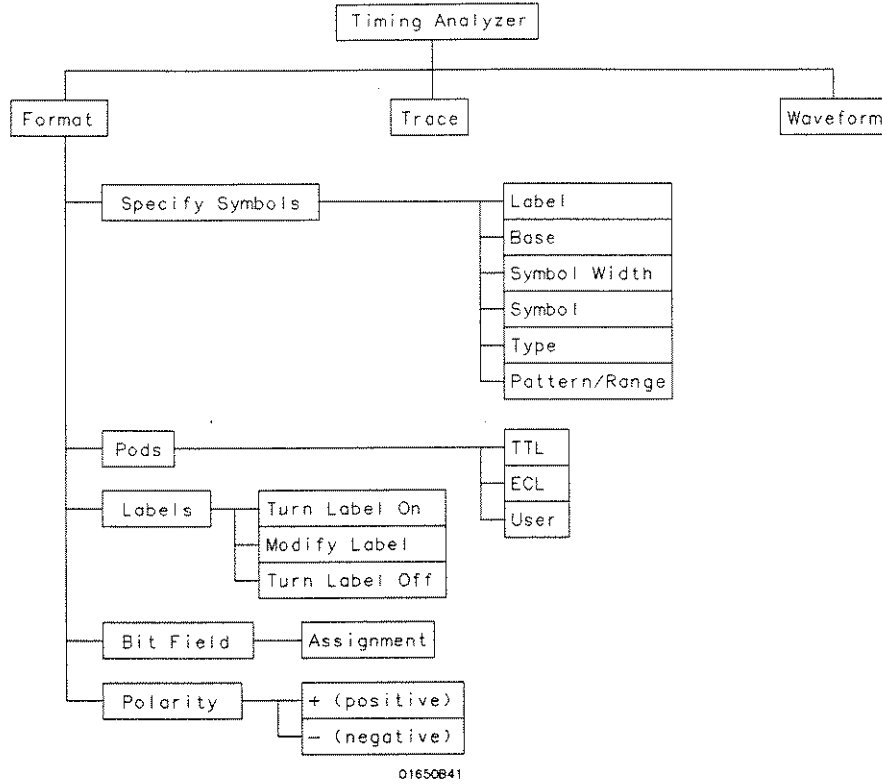
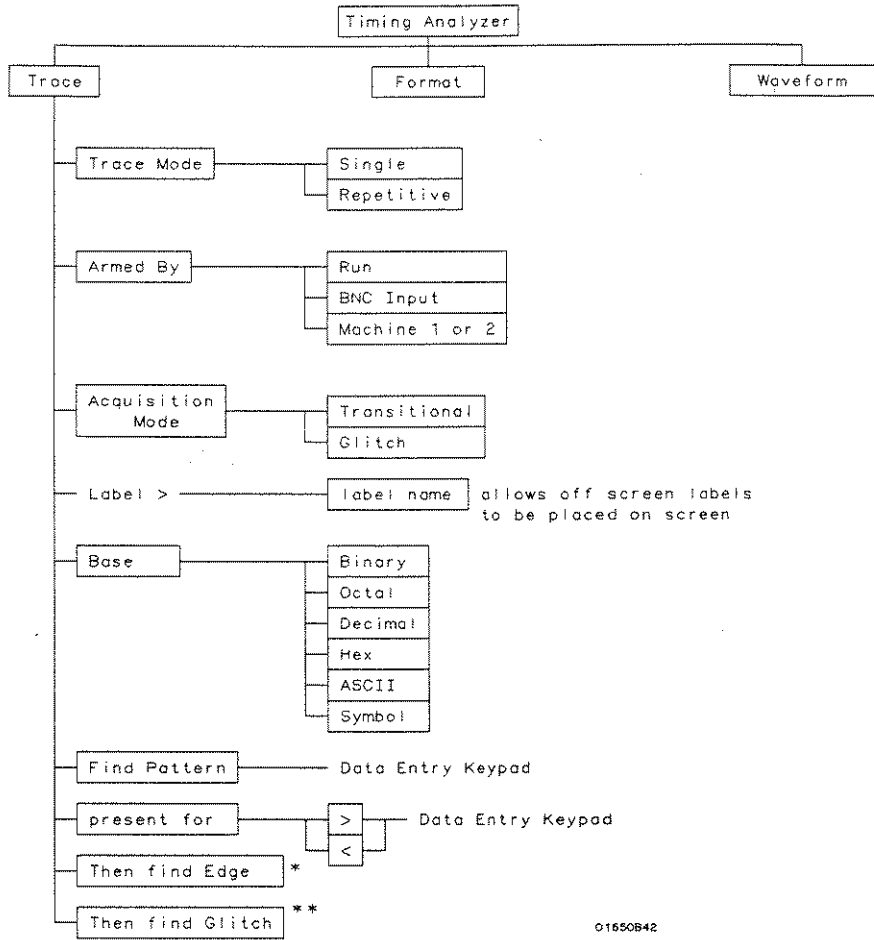

Figure 16-1. Timing Format Menu Map

## Timing Trace Menu Map



\* Only available when "greater than" is specified in "present for" field  
 \*\* Only available when "then find edge" is present and in Glitch mode

Figure 16-2. Timing Trace Menu Map

## Timing Waveform Menu Map

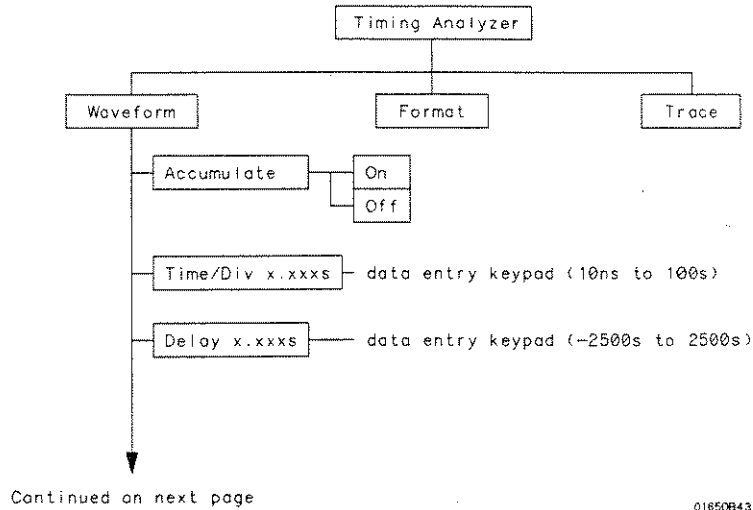

**Figure 16-3. Timing Waveform Menu Map**



Continued from previous page

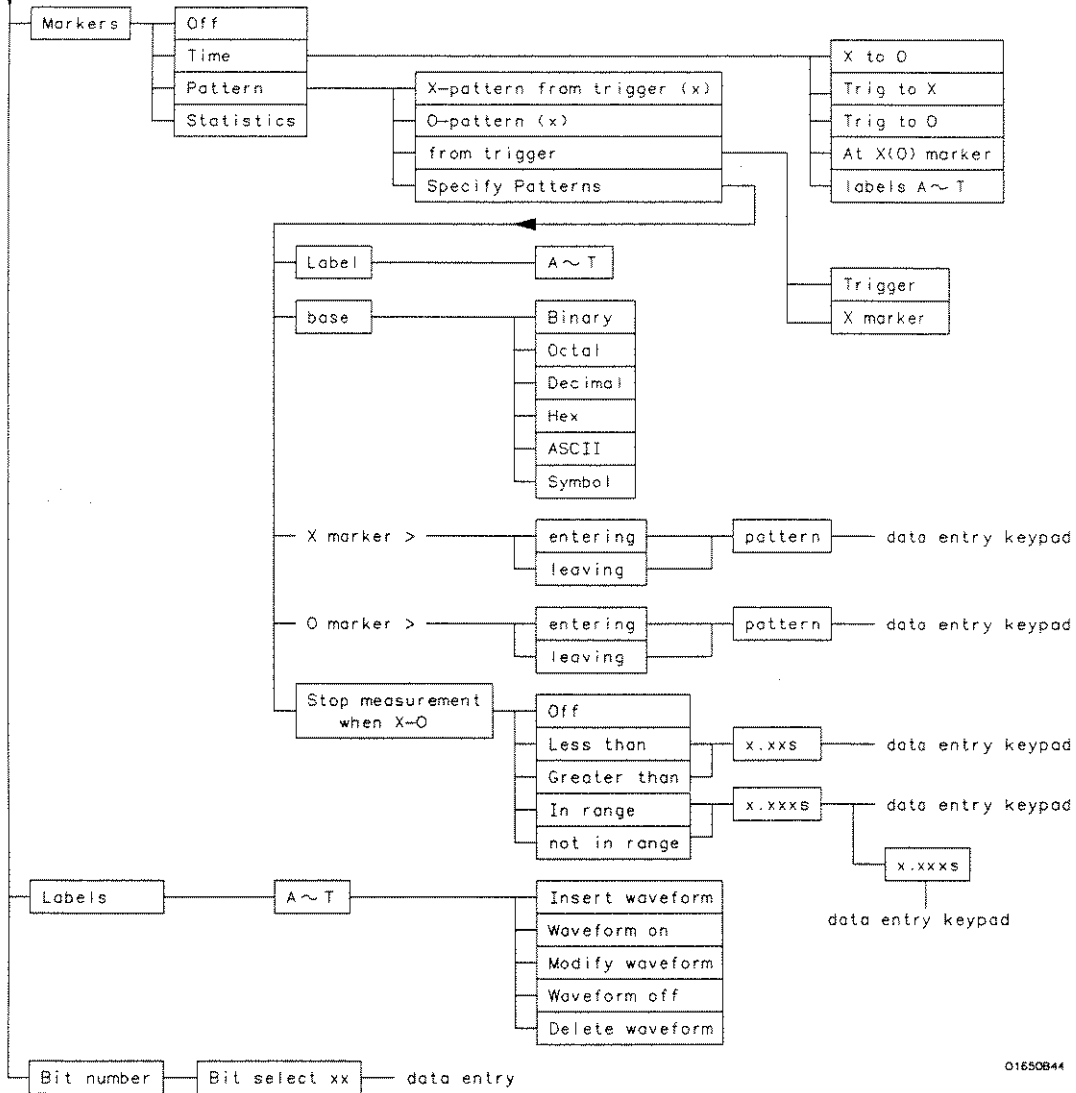

01650B44

Figure 8-3. Timing Waveform Menu Map (Continued)

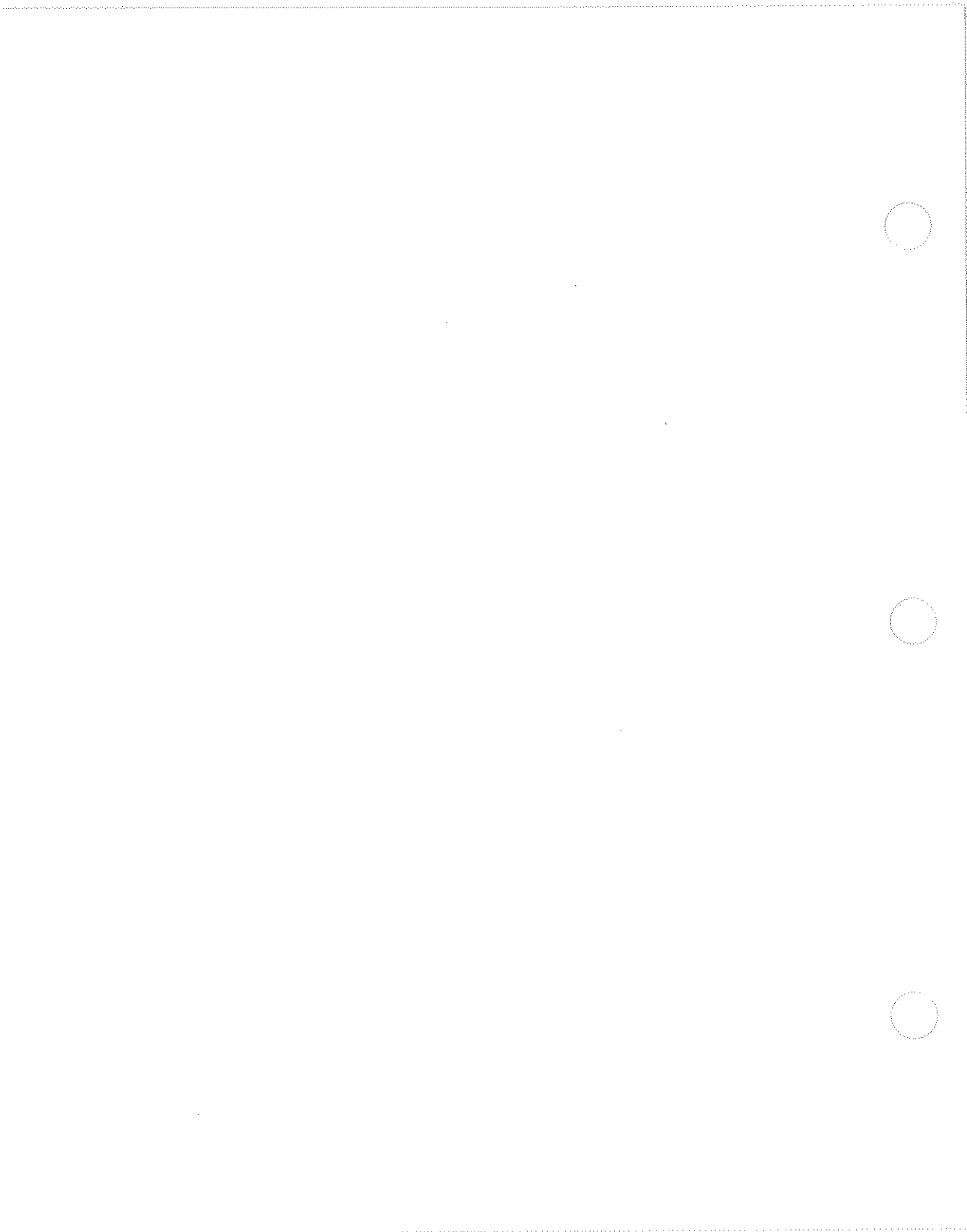

## Timing Format Specification Menu

---

### Introduction

This chapter describes the Timing Format Specification menu and all the pop-up menus that you will use on your timing analyzer. The purpose and function of each pop-up menu is explained in detail, and we have included many illustrations and examples to make the explanations clearer.

---

### Accessing the Timing Format Specification Menu

The Timing Format Specification menu can be accessed by pressing the FORMAT key on the front panel. If the State Format Specification Menu is displayed when you press the FORMAT key, you will have to switch analyzers. This is not a problem, it merely indicates that the last action you performed in the System Configuration Menu was on the state analyzer.

---

### Timing Format Specification Menu

The Timing Format Specification menu lets you configure the timing analyzer to group channels from your microprocessor into labels you assign for your measurements. You can set the threshold levels of the pods assigned to the analyzer, assign labels and channels, and specify symbols.

At power up, the logic analyzer is configured with a default setting. You can use this default setting to make a test measurement on the system under test. It can give you an idea of where to start your measurement. For an example of setting up configurations for the Timing analyzer, refer to the *Getting Started Guide* or "Timing Analyzer Measurement Example" in chapter 20 of this manual.

At power up the Timing Format Specification menu looks like that shown below:

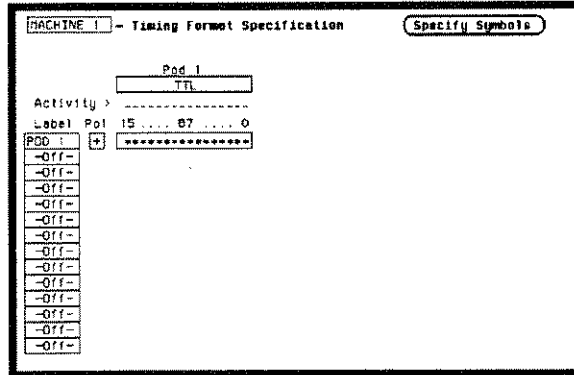

**Figure 17-1. Timing Format Specification Menu**

The Timing Format Specification menu for the HP 1653B is similar to that for the HP 1652B except that Pod 2 appears in the menu instead of Pod 5.

This menu shows only one pod assigned to each analyzer, which is the case at power up. Any number of pods can be assigned to one analyzer, from none to all five for the HP 1652B, and from none to two for the HP 1653B. In the Timing Format Specification menu, only three pods appear at a time in the display. To view any pods that are off screen, press the left/right ROLL key and rotate the KNOB. The pods are always positioned so that the lowest numbered pod is on the right and the highest numbered pod is on the left.

## Timing Format Specification Menu Fields

Five types of fields present in the menu are as follows:

- Label.
- Polarity (Pol).
- Bit assignments.
- Pod threshold.
- Specify Symbols.

A portion of the menu that is not a field is the Activity Indicators display. The indicators appear under the active bits of each pod, next to "Activity." When the logic analyzer is connected to your target system and the system is running, you will see † in the Activity Indicators display for each channel that has activity. These tell you that the signals on the channels are transitioning.

The fields in the Format menus are described in this following sections.

### Label

The label column contains 20 Label fields that you can define. Of the 20 labels, the logic analyzer displays only 14 in the Timing Format Specification menu at one time. To view the labels that are off screen, press the up/down ROLL key and rotate the KNOB. The labels scroll up and down. To deactivate the scrolling, press the ROLL key again.

To access one of the Label fields, place the cursor on the field and press SELECT. You will see a pop-up menu like that shown below.

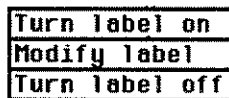

Figure 17-2. Label Pop-Up Menu

### Turn Label On

Selecting this option turns the label on and gives it a default letter name. If you turned all the labels on they would be named A through T from top to bottom. When a label is turned on, the bit assignment fields for that label, appear to the right of the label.

### **Modify Label**

If you want to change the name of a label, or want to turn a label on and give it a specific name, you would select the **Modify label** option. When you do, an Alpha Entry pop-up menu appears. You can use the pop-up menu and the keypad on the front panel to name the label. A label name can be a maximum of six characters.

### **Turn Label Off**

Selecting this option turns the label off. When a label is turned off, the bit assignments are saved by the logic analyzer. This gives you the option of turning the label back on and still having the bit assignments if you need them. The waveforms are also saved.

You can give the same name to a label in the state analyzer as in the timing analyzer without causing an error. The logic analyzer distinguishes between them. An example of this appears in "Using the Timing/State Analyzer" in chapter 7 of the *Getting Started Guide*.

### **Polarity (Pol)**

Each label has a polarity assigned to it. The default for all the labels is positive ( + ) polarity. You can change the polarity of a label by placing the cursor on the polarity field and pressing **SELECT**. This toggles the polarity between positive ( + ) and negative ( - ).

In the timing analyzer, negative polarity inverts the data.

### **Bit Assignment**

The bit assignment fields allow you to assign bits (channels) to labels. Above each column of bit assignment fields is a line that tells you the bit numbers from 0 to 15, with the left bit numbered 15 and the right bit numbered 0. This line helps you know exactly which bits you are assigning.

The convention for bit assignment is:

- \* (asterisk) indicates assigned bit
- . (period) indicates unassigned bit

At power up the 16 bits of Pod 1 are assigned to the timing analyzer and the 16 bits of Pod 5 are assigned to the state analyzer. To change a bit assignment configuration, place the cursor on a bit assignment field and press SELECT. You will see the following pop-up menu.

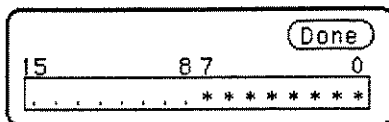

**Figure 17-3. Bit Assignment Pop-Up Menu**

Use the KNOB to move the cursor to an asterisk or a period and press SELECT. The bit assignment toggles to the opposite state of what it was before. When the bits (channels) are assigned as desired place the cursor on Done and press SELECT. This closes the pop-up and displays the new bit assignment.

Assigning one channel per label may be handy in some applications. This is illustrated in "Using the Timing/State Analyzer" in chapter 7 of the *Getting Started Guide* and chapter 21 of this manual. In addition, you can assign a channel to more than one label.

Labels may have from 1 to 32 channels assigned to them. If you try to assign more than 32 channels to a label, the logic analyzer will beep, indicating an error, and a message will appear at the top of the screen telling you that 32 channels per label is the maximum.

Channels assigned to a label are numbered from right to left by the logic analyzer. The least significant assigned bit (LSB) on the far right is numbered 0, the next assigned bit is numbered 1, and so on. Since 32 channels can be assigned to one label at most, the highest number that can be given to a channel is 31. Although labels can contain split fields, assigned channels are always numbered consecutively within a label as shown in figure 17-4.

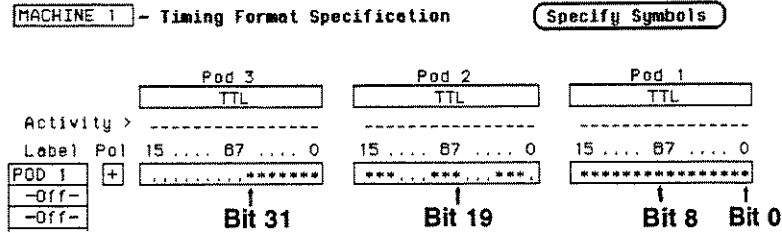

Figure 17-4. Numbering of Assigned Bits

**Pod Threshold**

Each pod has a threshold level assigned to it. For the HP 1653B Logic Analyzer, threshold levels may be defined for Pods 1 and 2 individually. For the HP 1652B Logic Analyzer, threshold levels may be defined for Pods 1, 2 and 3 individually, and one threshold for Pods 4 and 5. It does not matter if Pods 4 and 5 are assigned to different analyzers. Changing the threshold of one will change the threshold of the other.

If you place the cursor on one of the pod threshold fields and press SELECT, you will see the following pop-up menu.



Figure 17-5. Pod Threshold Pop-Up Menu

TTL sets the threshold at + 1.6 volts, and ECL sets the threshold at -1.3 volts.

The User-defined option lets you set the threshold to a specific voltage between -9.9 V and + 9.9 V. If you select this option you will see a Numeric Entry pop-up menu as shown.

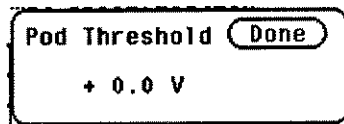

Figure 17-6. User-Defined Numeric Entry Pop-Up Menu



You can change the value in the pop-up either with the keypad on the front panel or with the KNOB, which you rotate until you get the desired voltage. When the correct voltage is displayed, press SELECT. The pop-up will close and your new threshold will be placed in the pod threshold field.

## Specify Symbols Menu

The Specify Symbols field differs from the other fields in the Timing Format Specification menu in that it displays a complete menu instead of a pop-up.

The logic analyzer supplies Timing and State Symbol Tables in which you can define a mnemonic for a specific bit pattern of a label. When measurements are made by the timing analyzer, the mnemonic is displayed where the bit pattern occurs if the Symbol base is selected.

It is possible for you to specify up to 200 symbols in the logic analyzer. If you have only one of the internal analyzers on, all 200 symbols can be defined in it. If both analyzers are on, the 200 symbols are split between the two. For example, analyzer 1 may have 150, leaving 50 available for analyzer 2.

To access the Symbol Table in the Timing Format Specification menu, place the cursor on the **Specify Symbols** field and press SELECT. You will see a new menu as shown in figure 17-7. This is the default setting for the Symbol Table in both the timing and state analyzers.

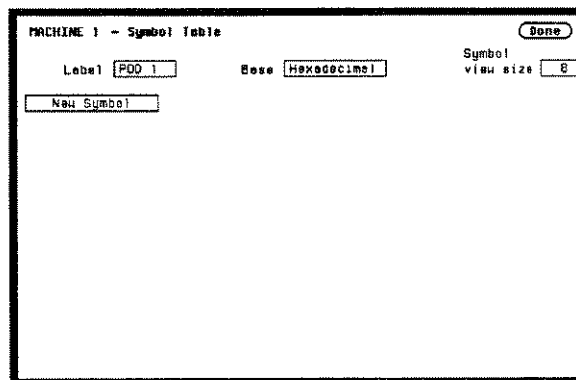

Figure 17-7. Symbol Table Menu

---

## Specify Symbols Menu Fields

There are four fields in the Symbol Table menu. They are:

- Label
- Base
- Symbol view size
- Symbol name

**Label** The Label field identifies the label for which you are specifying symbols. If you select this field, you will get a pop-up that lists all the labels turned on for that analyzer.



CLOCK
AS
LDS
UDS
DTACK
R/W
ADDR
DATA

**Figure 17-8. Label Pop-Up Menu**

Each label has a separate symbol table. This allows you to give the same name to symbols defined under different labels. In the Label pop-up select the label for which you wish to specify symbols.

**Base** The Base field tells you the numeric base in which the pattern will be specified. The base you choose here will affect the **Find Pattern** field of the Timing Trace Specification menu. This is covered later in this chapter.

To change the base, place the cursor on the Base field and press SELECT. You will see the following pop-up menu.

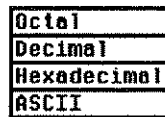

**Figure 17-9. Base Pop-Up Menu**

If more than 20 channels are assigned to a label, the Binary option is not offered in the pop-up. The reason for this is that when a symbol is specified as a range, there is only enough room for 20 bits to be displayed on the screen.

Decide which base you want to work in and choose that option from the numeric Base pop-up menu.

If you choose the ASCII option, you can see what ASCII characters the patterns and ranges defined by your symbols represent. ASCII characters represented by the decimal numbers 0 to 127 (hex 00 to 7F) are offered on your logic analyzer. Specifying patterns and ranges for symbols is discussed in the next section.



---

You cannot specify a pattern or range when the base is ASCII. First define the pattern or range in one of the other bases, then switch to ASCII to see the ASCII characters.

---

**Symbol View Size** The Symbol view size field lets you specify how many characters of the symbol name will be displayed when the symbol is referenced in the Timing Trace Specification menu and the Timing Waveforms menu. Selecting this field gives you the following pop-up.

3
4
5
6
7
8
9
10
11
12
13
14
15
16

**Figure 17-10. Symbol View Size Pop-Up Menu**

You can have the logic analyzer display from 3 to all 16 of the characters in the symbol name. For more information see "Timing Trace Specification Menu" in Chapter 18 and the "Timing Waveforms Menu" in Chapter 19.

**Symbol Name** When you first access the Symbol Table, there are no symbols specified. The symbol name field reads "New Symbol." If you select this field, you will see an Alpha Entry pop-up menu on the display. Use the pop-up menu and the keypad on the front panel to enter the name of your symbol. A maximum of 16 characters can be used in a symbol name. When you select the Done field in the Alpha Entry pop-up menu the name that appears in the symbol name field is assigned and two more fields appear in the display.

MACHINE 1 - Symbol Table Done

Label  Base  Symbol view size

**Figure 17-11. Symbol Defined as a Pattern**

The first of these fields defines the symbol as either a Pattern or a Range. If you place the cursor on this field and press SELECT, it will toggle between **Pattern** and **Range**.

When the symbol is defined as a pattern, one field appears to specify what the pattern is. Selecting this field gives you a pop-up with which you can specify the pattern. Use the keypad and the DON'T CARE key on the front panel to enter the pattern. Be sure to enter the pattern in the numeric base that you specified in the **Base** field.

Specify Pattern:  
85C4

**Figure 17-12. Specify Pattern Pop-Up**

If the symbol is defined as a range, two fields appear in which you specify the upper and lower boundaries of the range.

MACHINE 1 - Symbol Table Done

Label  Base  Symbol view size

**Figure 17-13. Symbol Defined as a Range**

Selecting either of these fields gives you a pop-up with which you can specify the boundary of the range.

Specify Number:  
1FFF

**Figure 17-14. Specify Range Pop-Up**

You can specify ranges that overlap or are nested within each other. Don't cares are not allowed.

To add more symbols to your symbol table, place the cursor on the last symbol defined and press SELECT. A pop-up menu appears as shown.

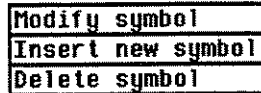

**Figure 17-15. Symbol Pop-Up Menu**

The first option in the pop-up is Modify symbol. If you select this option, you will see an Alpha Entry pop-up menu with which you can change the name of the symbol.

The second option in the pop-up is Insert new symbol. It allows you to specify another symbol. When you select it, you will see an Alpha Entry pop-up menu. Use the menu and the keypad on the front panel to enter the name of your new symbol. When you select Done, your new symbol will appear in the Symbol Table. The third option in the pop-up is Delete symbol. If you select this option, the symbol will be deleted from the Symbol Table.

### **Leaving the Symbol Table Menu**

When you have specified all your symbols, you can leave the Symbol Table menu in one of two ways. One method is to place the cursor on the Done field and press SELECT. This puts you back in the Format Specification menu that you were in before entering the Symbol Table. The other method is to press the FORMAT, TRACE, or DISPLAY keys on the front panel to get you into the respective menu.

## Timing Trace Specification Menu

---

### Introduction

This chapter describes Timing Trace Specification menu and all the pop-up menus that you will use on your timing analyzer. The purpose and function of each pop-up menu is explained in detail, and we have included many illustrations and examples to make the explanations clearer.

---

### Accessing the Timing Trace Specification Menu

The Timing Trace Specification menu can be accessed by pressing the TRACE key on the front panel. If the State Trace Specification menu is displayed when you press the TRACE key, you will have to switch analyzers. This is not a problem, it merely indicates that the last action you performed in the System Configuration Menu was on the state analyzer.

---

### Timing Trace Specification Menu

The Trace Specification menus allow you to configure the logic analyzer to capture only the data of interest in your measurement. In the timing analyzer you can configure the analyzer to trigger on specific patterns, edges, or glitches. The Timing Trace Specification menu lets you specify the trigger point for the logic analyzer to start capturing data and the manner in which the analyzer will capture data. You configure the timing analyzer to find a pattern first and then a transition in the signal or signals.

At power up, the logic analyzer is configured with a default setting. You can use this default setting to make a test measurement on the system under test. It can give you an idea of where to start your measurement. For an example on setting up configurations for the Timing analyzer, refer to the *Getting Started Guide* or "Timing Analyzer Measurement Example" in Chapter 20 of this manual.

At power up the Timing Trace menu looks like that shown below.

MACHINE 1 - Timing Trace Specification

Trace mode

Armed by  Acquisition mode

---

Label >

Base >

Find Pattern

present for >

Then find Edge

**Figure 18-1. Timing Trace Specification Menu**

The menu is divided into two sections by a horizontal line. The top section contains the fields that you use to specify the data acquisition. The bottom section contains the fields for setting the trigger point.

## Timing Trace Specification Menu Fields

The fields in the Timing Trace Specification menu are as follows:

- Trace mode.
- Armed by.
- Acquisition mode.
- Label.
- Base.
- Find Pattern.
- Pattern Duration (present for \_\_\_\_).
- Then find Edge.

These fields are described in this chapter.



**Trace Mode** With the **Trace mode** field you specify the mode in which the timing analyzer will trace. You have two choices for Trace mode: Single and Repetitive. If you place the cursor on the field and press SELECT, the field toggles from one mode to the other.

Single Trace mode acquires data once per trace. Repetitive Trace mode repeats single acquisitions until the STOP key on the front panel is pressed, or if Stop measurement has been selected and the stop measurement condition has been met.

If both analyzers are on, only one Trace mode can be specified. Specifying one trace mode for one analyzer sets the same trace mode for the other analyzer.

**Armed By** The **Armed by** field lets you specify how your timing analyzer is to be armed. The analyzer can be armed by the RUN key, the other analyzer, the scope or an external instrument through the BNC Input port.

When you select the **Armed by** field, a pop-up menu appears like that shown below. Use this menu to select the arming option for your analyzer.

Armed by

Run
BNC Input
Machine 1
Scope

**Figure18-2. Armed By Pop-Up Menu**

**Acquisition Mode** The **Acquisition mode** field allows you to specify the mode in which you want the timing analyzer to acquire data. You are given two choices for the mode of acquisition: Transitional and Glitch . If you place the cursor on this field and press SELECT, the field toggles from one mode to the other.

### Transitional Acquisition Mode

When the logic analyzer is operating in the Transitional Acquisition mode, it samples the data at regular intervals, but it stores data in memory only on transitions in the signals. A time tag that is stored with each sample allows reconstruction of the samples in the Timing Waveforms display.

Transitional timing always samples at a rate of 100 MHz (10 ns/sample). This provides maximum timing resolution even in records that span long time windows. Time covered by a full memory acquisition varies with the number of pattern changes in the data. If there are many transitions, the data may end prior to the time window desired because the memory is full. However, a prestore qualification in your logic analyzer insures that data will be captured and displayed between the left side of the screen and the trigger point.

Figure 18-3 illustrates Transitional acquisition, comparing it to Traditional acquisition.

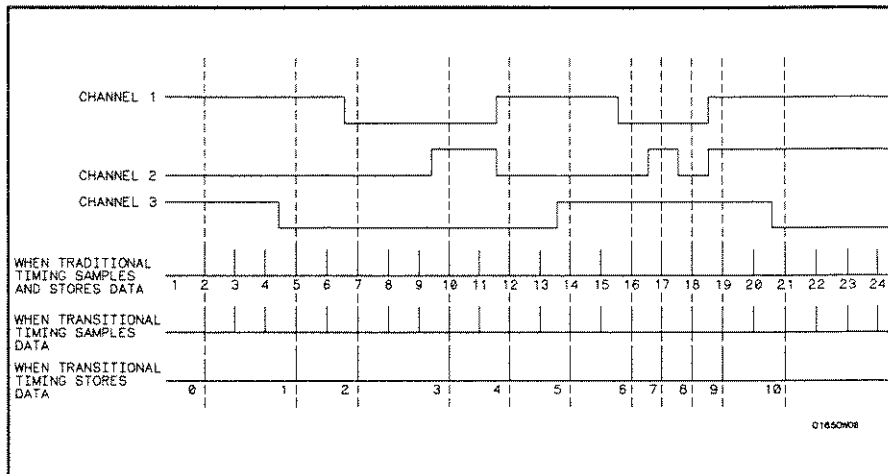

Figure 18-3. Transitional vs. Traditional Acquisition

Traditional timing samples and stores data at regular intervals. Transitional timing samples data at regular intervals but stores a sample only when there has been a transition on one or more of the channels. This makes it possible for Transitional timing to store more information in the same amount of memory.

### Glitch Acquisition Mode

A glitch is defined as any transition that crosses logic threshold more than once between samples. It can be caused by capacitive coupling between traces, by power supply ripples, or a number of other events. Since a glitch can cause major problems in your system, you can use the Glitch mode to find it.

Your logic analyzer has the capability of triggering on a glitch and capturing all the data that occurred before it. The glitch must have a width of at least 5 ns at threshold in order for the analyzer to detect it.

If you want your timing analyzer to trigger on a glitch in the data, set the Acquisition mode to Glitch. This causes several changes in the analyzer. One change is that a field for glitch detection in each label is added to the Timing Trace Specification menu, as shown:

Then find  
Edge   
or  
Glitch

**Figure 18-4. Glitch Specification Field**

With these glitch detection fields you specify on which channel or channels you want the analyzer to look for a glitch. These fields are discussed in more detail in "Then Find Edge" later in this chapter.

Glitch Acquisition mode causes the storage memory to be cut in half from 1k to 512. Half the memory (512) is allocated for storing the data sample, and the other half for storing the second transition of a glitch in a sample. Every sample is stored.

The sample rate varies from 20 Hz to 50 MHz (50 Ms/sample to 20 ns/sample) and is automatically selected by the timing analyzer to insure complete data in the window of interest.

When your timing analyzer triggers on a glitch and displays the data, the glitch appears in the waveform display as shown below.

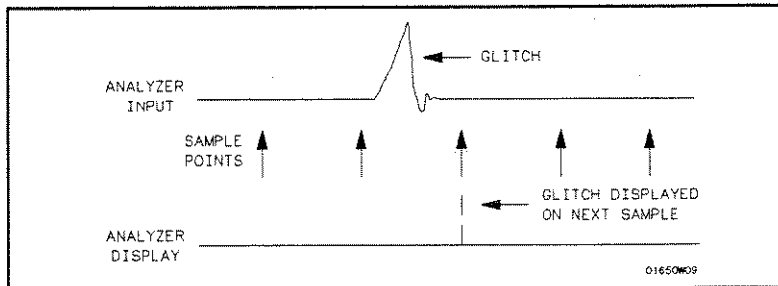

**Figure 18-5. Glitch in Timing Waveform**

**Label** The **Label** fields contain the labels that you define in the Timing Format Specification menu. If there are more labels than can fit on screen, use the left/right ROLL key and the KNOB to view those that are not displayed.

**Base** The **Base** fields allow you to specify the numeric base in which you want to define a pattern for a label. The **Base** fields also let you use a symbol that was specified in the Timing Symbol Table for the pattern. Each label has its own base defined separately from the other labels. If you select one of the **Base** fields, you will see the following pop-up menu. Decide which base you want to define your pattern in and select that option.

Binary
Octal
Decimal
Hexadecimal
ASCII
Symbol

**Figure 18-6. Base Pop-up Menu**

One of the options in the Base pop-up is ASCII . It allows you to see characters that are represented by the pattern you specified in the **Find Pattern** field.

```
Label >  POD 1
Base >   ASCII
Find
Pattern  $  %
```

**Figure 18-7. ASCII Defined as Numeric Base**

Notice in the figure above that the **Find Pattern** field is no longer a selectable field when the base is ASCII . You cannot specify ASCII characters directly. You must specify a pattern in one of the other bases; then you can switch the base to ASCII and see what characters the pattern represents.

The Symbol option in the Base pop-up allows you to use a symbol that has been specified in the Timing Symbol Tables as a pattern or specify absolute and enter another pattern. You specify the symbol you want to use in the **Find Pattern** field.

## **Find Pattern**

With the **Find Pattern** fields, you configure your timing analyzer to look for a certain pattern in the data. Each label has its own pattern field that you use to specify a pattern for that label.

During a run, the logic analyzer looks for a pattern in your data which is the logical AND of all the labels' patterns. That is, it looks for a simultaneous occurrence of the specified patterns. When it finds the pattern, it triggers at the point that you specified in the **Then find Edge** fields. See "Then Find Edge" later in this chapter for more information about edge triggering.

You select a **Find Pattern** field with one of two methods. The first method is to place the cursor on the Find Pattern field and press SELECT. The second method is to place the cursor on the Find Pattern field and press one of the alphanumeric keys on the front-panel keypad. Both methods give you a pop-up similar to that shown in figure 18-8.

Specify Pattern:  
2425

**Figure 18-8. Specify Pattern Pop-Up for Find Pattern**

The pop-up varies depending on the base you choose and the number of channels you assign to that label. If you press a key on the keypad to open the pop-up, the character on the key is placed in the first location of the pattern.

Enter your pattern in the pop-up and press SELECT. The pattern appears under the label in the **Find Pattern** field.

As mentioned previously in "Base", if you specify ASCII as the base for the label, you won't be able to enter a pattern. You must specify one of the other numeric bases to enter the pattern. Then you can switch the base to ASCII and see what ASCII characters the pattern represents. If you choose Symbols in the Base field, you can use one of the symbols specified in the Timing Symbol Tables as the pattern. The **Find Pattern** field looks similar to that below:

Label >   
Base >   
Find  
Pattern

**Figure 18-9. Symbol Defined in Base Field**

If you select this field you get a pop-up similar to that shown:

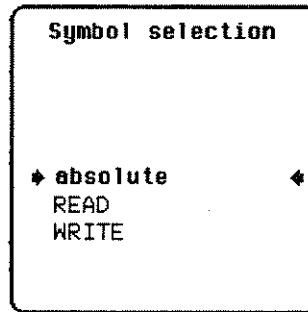

**Figure 18-10. Symbol Selection Pop-Up for Find Pattern**

The pop-up lists all the symbols defined for that label. It also contains an option "absolute xxxx." Choosing this option gives you another pop-up with which you specify a pattern not given by one of your symbols.

To select an option from the pop-up, use the KNOB to scroll the symbols up and down until the desired symbol is between the two arrows. Press SELECT. The symbol name appears in the Find Pattern field under the label.

When you specify symbols in the Timing Symbol Tables, you also specify the number of characters in the symbol name that are to be displayed. If you specify only three characters of a symbol name in the Symbol menu, only REA of READ and WRI of WRITE would be displayed in the Find Pattern Field. In addition, only the first three letters of "absolute" would be displayed.

### **Pattern Duration (present for \_\_\_\_)**

There are two fields with which you specify the Pattern Duration. They are located next to **present for \_\_\_\_** in the Timing Trace Specification menu. You use these fields to tell the timing analyzer to trigger before or after the specified pattern has occurred for a given length of time.

The first field can be set to ">" (greater than) or "<" (less than). If you place the cursor on this field and press SELECT, it toggles between > and <. The second field specifies the duration of the pattern. If you select > in the first field, you can set the duration to a value between 30 ns and 10 ms. If you select < in the first field, you can set the duration to a value between 40 ns and 10 ms. If you attempt to set the duration to a value outside the given range, the analyzer will automatically set it to the nearest limit.

To change the value of the pattern duration, place the cursor on the second field and either press SELECT to get a pop-up menu, or just press one of the numeric keys on the front-panel keypad. Both methods give you a Numeric Entry pop-up similar to that shown.

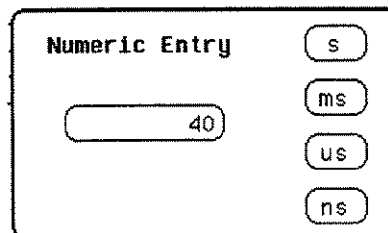

**Figure 18-11. Pattern Duration (present for) Pop-Up**

With the front-panel keypad, enter the desired pattern duration. Use the KNOB to place the cursor on the correct timing units, then press SELECT. Your value for Pattern Duration will appear in the field.

**Note** 

If you press a key on the keypad to open the pop-up, the number that you pressed will appear in the entry field replacing the previous value. To restore the original value press the CLEAR ENTRY key.



As an example, suppose you configure the **present for** \_\_\_ field as shown:

present for

#### Figure 18-12. Example of Pattern Duration (Greater Than)

This configuration tells the timing analyzer to look for the pattern you specified that occurs for a period of time greater than 50 ns. Once the timing analyzer has found the pattern, it can look for the trigger.

Choosing < (less than) forces glitch and edge triggering off, and the timing analyzer triggers immediately at the end of the pattern that meets the duration requirements. The fields with which you specify edges and glitches do not appear in the menu. For instance, configure the **present for** \_\_\_ field as shown below.

present for

#### Figure 18-13. Example of Pattern Duration (Less Than)

The analyzer triggers when it sees the pattern you specified, and that occurs for a period less than 100 ns. The pattern must also be valid for at least 20 ns.

### Then Find Edge

With the **Then find Edge** fields you can specify the edges (transitions) of the data on which your timing analyzer triggers. You can specify a positive edge, a negative edge, or either edge. Each label has its own edge trigger specification field so that you can specify an edge on any channel.

When you specify an edge on more than one channel, the timing analyzer logically ORs them together to look for the trigger point. That is, it triggers when it sees any one of the edges you specified. It also ANDs the edges with the pattern you specified in the **Find Pattern** fields. The logic analyzer triggers on an edge following the valid duration of the pattern while the pattern is still present. To specify an edge, place the cursor on one of the **Then find Edge** fields and press **SELECT**. You will see a pop-up similar to that shown in the following figure.

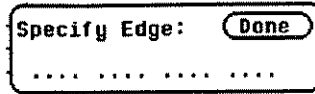

**Figure 18-14. Specify Edge Pop-Up for Then Find Edge**

Your pop-up may look different than this depending on the number of channels you assigned to the label. Each period in the pop-up indicates that no edge is specified for that channel.

To specify a negative edge, place the cursor on one of the periods in the pop-up and press SELECT once. The period changes to ↓, as shown:

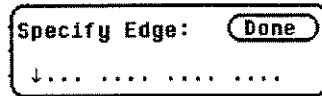

**Figure 18-15. Negative Edge Specified**

To specify a positive edge, place the cursor on one of the periods and press SELECT twice. The period changes to ↑, as shown:

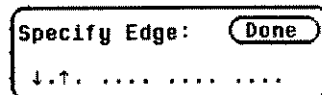

**Figure 18-16. Positive Edge Specified**

If you want the analyzer to trigger on either a positive or a negative edge, place the cursor on a period and press SELECT three times. The period changes to ↓↑, as shown:

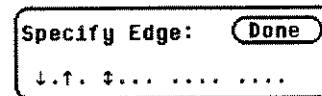

**Figure 18-17. Either Edge Specified**

If you want to delete an edge specification, place the cursor on the arrow for that channel and press SELECT until you see a period. To clear an entire label, press the CLEAR ENTRY key on the front panel.

When you have finished specifying edges, place the cursor on the Done field and press SELECT to close the pop-up.

**Note** 

If you are not in Binary base, you will see dollar signs (\$\$..) in the Then find Edge field when you close the pop-up. These indicate that edges have been specified; however, the logic analyzer can't display them correctly unless you have selected Binary for the base.

When you set the Acquisition mode on **Glitch**, a glitch detection field, for each label, is added to the screen. These fields allow you to specify glitch triggering on your timing analyzer. Selecting one of these fields displays the following pop-up menu.

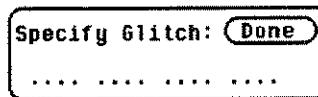

**Figure 18-18. Specify Glitch Pop-Up for Then Find Glitch**

Your pop-up may look different depending on the number of channels you have assigned to the label. Each period indicates that the channel has not been specified for glitch triggering.

To specify a channel for glitch triggering, place the cursor on one of the periods and press SELECT. The period is replaced with an asterisk, indicating that the logic analyzer will trigger on a glitch on this channel.

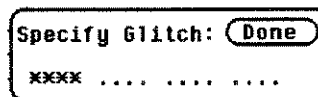

**Figure 18-19. Glitches Specified**

If you want to delete a glitch specification, place the cursor on the asterisk and press SELECT. The asterisk is replaced with a period.

---

**Note** 

If you are not in Binary base, you will see dollar signs (\$\$.) in the Glitch field when you close the pop-up. This indicates that glitches have been specified; however, the logic analyzer can't display them correctly unless you have selected Binary for the base.

---

When more than one glitch has been specified, the logic analyzer logically ORs them together. In addition, the logic analyzer ORs the glitch specifications with the edge specifications, then ANDs the result with the pattern you specified in the Find Pattern fields in order to find the trigger point. A boolean expression illustrating this is:

$(\text{glitch} + \text{glitch} + \text{edge} + \text{edge}) * \text{pattern}$

---

**Note** 

If you select < (less than) in the **present for** \_\_\_ field, edge and glitch triggering are turned off. The Then find Edge or Glitch field no longer appears on the screen. The logic analyzer then triggers only on the pattern specified in the Find Pattern fields.

---

## Timing Waveforms Menu

### Introduction

The Timing Waveforms menu is the display menu of the timing analyzer. This chapter describes the Timing Waveforms menu and how to interpret it. It also tells you how to use the fields to manipulate the displayed data so you can find your measurement answers.

There are two different areas of the timing waveforms display: the menu area and the waveforms area. The menu area is in the top one-fourth of the screen and the waveforms area is the bottom three-fourths of the screen.

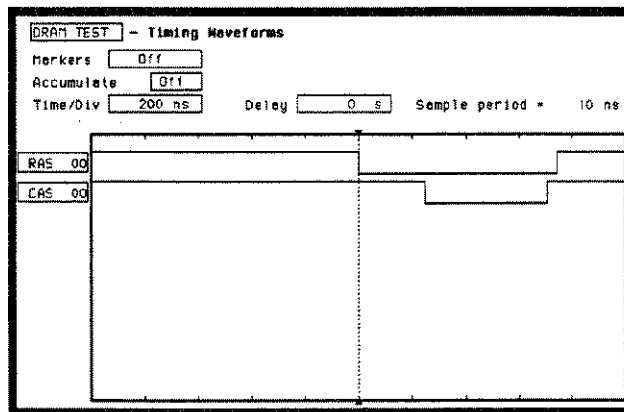

Figure 19-1. Timing Waveforms Menu

The waveforms area displays the data that the timing analyzer acquires. The data is displayed in a format similar to an oscilloscope with the horizontal axis representing time and the vertical axis representing amplitude. The basic differences between an oscilloscope display and the timing waveforms display are: in the timing waveforms display the vertical axis only displays highs (above threshold) and lows (below threshold). Also, the waveform lows are represented by a thicker line for easy differentiation.

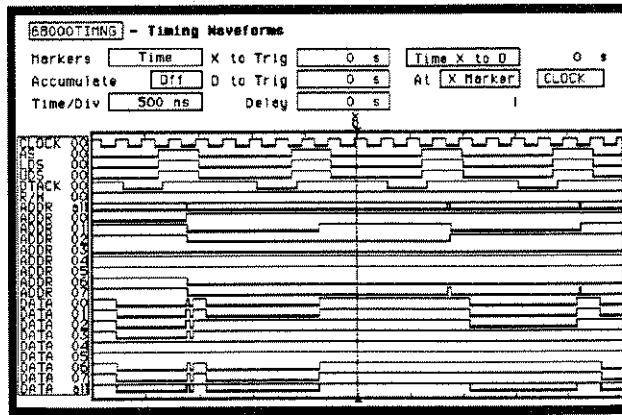

Figure 19-2. Timing Waveforms Menu with 24 Waveforms

## Accessing the Timing Waveforms Menu

The Timing Waveforms Menu is accessed by the pressing the DISPLAY key on the front panel when the timing analyzer is on. It will automatically be displayed when you press RUN.

## Timing Waveforms Menu Fields

The menu area contains fields that allow you to change the display parameters, place markers, and display waveform measurement parameters.

```
68000TIMNG - Timing Waveforms
Markers  X to Trig   
Accumulate  O to Trig  At  
Time/Div  Delay  
```

Figure 19-3. Timing Waveforms Menu Fields

**Markers** The Markers field allows you to specify how the X and O markers will be positioned on the timing data. The options are:

- Off
- Time
- Patterns
- Statistics
- Markers Off/Sample Period

When the markers are off they are not visible and the sample period is displayed. In transitional timing mode, the sample period will always be 10 ns. In Glitch mode, the sample period is controlled by the Time/Div setting and can be monitored by turning the markers off.



The sample period displayed is the sample period of the last acquisition. If you change the Time/Div setting, you must press RUN to initiate another acquisition before the sample period is updated.

Although the markers are off, the logic analyzer still performs statistics, so if you have specified a stop measurement condition the measurement will stop if the pattern specified for the markers is found.

```
68000TIMNG - Timing Waveforms
Markers 
Accumulate 
Time/Div  Delay  Sample period = 10 ns
```

Figure 19-4. Markers Off

## Markers Time

When the markers are set to Time, you can place the markers on the waveforms at events of interest and the logic analyzer will tell you:

- Time X to Trig(ger).
- Time O to Trig(ger).
- Time X to O.

To position the markers, move the cursor to the field of the marker you wish to position and press SELECT. A pop-up will appear showing the current time for that marker. Either rotate the KNOB or enter a numeric value from the keypad to change the position of that marker. Pressing SELECT when you are finished positions the marker and closes the pop-up.

When the cursor is on either the X to Trig or O to Trig fields, you can also enter a value directly from the keypad without pressing SELECT.

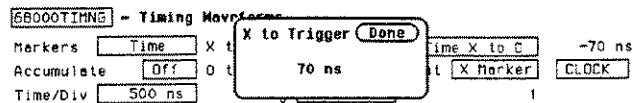

Figure 19-5. Markers Time

The Time X to O field will change according to the position of the X and O markers. If you place the cursor on the Time X to O field and press SELECT, another pop-up will appear showing you all three times: X to Trigger, O to Trigger, and Time X to O.

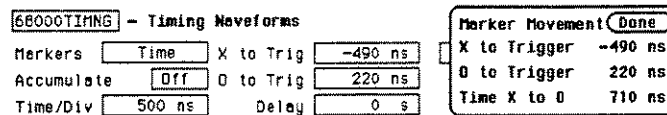

Figure 19-6. Time X to O Pop-up

If you rotate the KNOB while this pop-up is open, both X and O markers will move, but the relative placement between them will not change.



## Markers Patterns

When the markers are set to patterns, you can specify the patterns on which the logic analyzer will place the markers. You can also specify how many occurrences of each marker pattern the logic analyzer looks for. This use of the markers allows you to find time between specific patterns in the acquired data.

The screenshot shows a dialog box titled "Specify Patterns" within the "Timing Waveforms" menu. The dialog has several fields: "Markers" is set to "Patterns"; "Find x-pattern" is set to "0" from "Trigger"; "Accumulate" is set to "Off"; "Find o-pattern" is set to "0" from "Trigger"; "Time/Div" is set to "200 ns"; "Delay" is set to "0 s"; and "Time X to O" is set to "0 s".

Figure 19-7. Markers Patterns

Patterns for each marker (X and O) can be specified. Patterns can be specified for both markers in each label. The logic analyzer searches for the logical "and" of patterns for all labels even though only one label can be displayed at a time. You can also specify whether the marker is placed on the pattern at the beginning of its occurrence (entering) or at the end of its occurrence (leaving) as shown in figure 19-8.

The screenshot shows a "Marker Patterns" pop-up menu. It includes a "Done" button in the top right. The "Label" is set to "A" and the "Base" is set to "Hexadecimal". There are two rows for markers: "X Marker" and "O Marker", both set to "entering" and with a pattern of "XXXXXXXX". The "Stop measurement" is set to "X-O" with the option "Less than" and a value of "10 ns". The "Store exception to disk" is set to "On" with a "File name" of "EXCEPTION". There is a "File description" field at the bottom.

Figure 19-8. Marker Patterns Pop-up menu

## Stop Measurement

Another feature of markers set to patterns is the Stop measurement when Time X-O \_\_\_\_\_. The options are: Less than, Greater than, In range, Not in range

With this feature you can use the logic analyzer to look for a specified time or range of time between the marked patterns and have it stop acquiring data when it sees this time between markers. (The X marker must precede the O marker.)

Also available is **Store exception to disk** which allows you to specify a file on the disk that exceptions can be stored in. The default filename is **EXCEPTION**.

**Note** 

The upper and lower range boundaries must not be the same value. For example, if you want to stop a measurement when the X and O markers are in range of 200 ns, you should set the range values to 190 ns and 210 ns. This eliminates erroneous measurement termination.

**Markers Statistics**

When statistics are specified for markers, the logic analyzer will display the following:

- Number of total runs.
- Number of valid runs (runs where markers were able to be placed on specified patterns).
- Minimum time between the X and O markers.
- Maximum time between the X and O markers.
- Average time between the X and O markers.

Statistics are based on the time between markers which are placed on specific patterns. If a marker pattern is not specified, the marker will be placed on the trigger point by the logic analyzer. In this case the statistical measurement will be the time from the trigger to the specified marker. How the statistics will be updated depends on the timing trace mode (repetitive or single).

In repetitive, statistics will be updated each time a valid run occurs until you press **STOP**. When you press **RUN** after **STOP**, the statistics will be cleared and will restart from zero.

In single, each time you press **RUN** an additional valid run will be added to the data and the statistics will be updated. This will continue unless you change the placement of the X and O markers between runs.

**Accumulate Mode**

Accumulate mode is selected by toggling the **Accumulate ON/OFF** field in the **Timing Waveforms** menu. When accumulate is on, the timing analyzer displays the data from a current acquisition on top of the previously acquired data.



The next field to the right of the **At** \_\_\_\_\_ **Marker** field will pop up when selected and show you all the labels assigned to the timing analyzer as shown below.

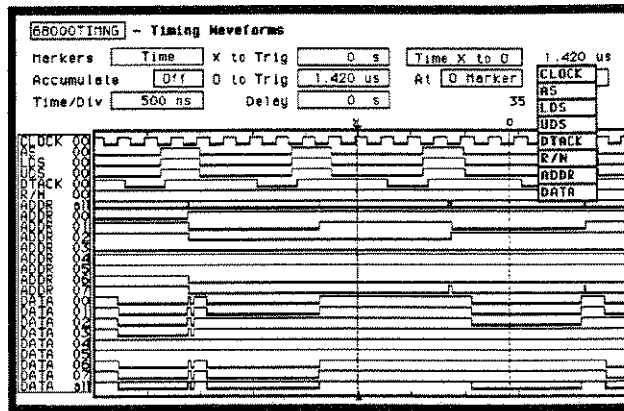

Figure 19-10. Label Option Pop-up

## Time/Div (time per division) Field

The time per division field allows you to change the width of the time window of the Timing Waveforms menu.

When the pop-up is open you can change the time per division by rotating the KNOB or entering a numeric value from the keypad. When you rotate the KNOB, the time per division increments or decrements in 1-2-5 sequence from 10 ns/div to 50 ms/div.

### Note

Sample period is fixed at 10 ns in the Transitional acquisition mode.

When you enter a value from the keypad, the time per division does not have to be a 1-2-5 sequence.

### Note

In Glitch mode, changing the Time/Div setting changes the sample period for the next run. To view the sample period after the next run, turn the markers off if they are on and press RUN.

## Delay Field

The **Delay** field allows you to enter a delay. The delay can be either positive or negative. Delay allows you to place the time window (selected by Time/Div) of the acquired data at center screen.

The inverted triangle in the horizontal center of the waveforms area of the display represents trigger + delay. The vertical dotted line represents the trigger point (see figure 19-11).

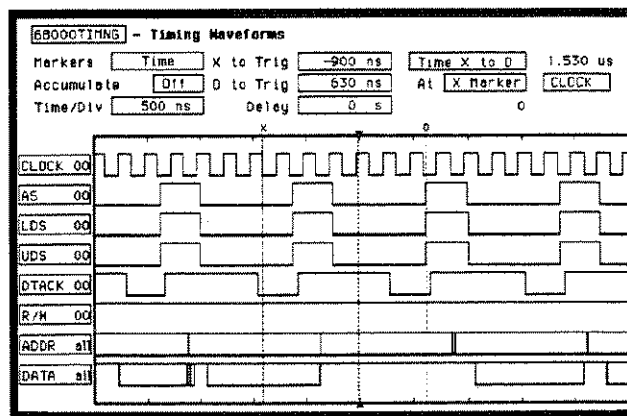

Figure 19-11. Trigger and Trace Points

If you want to trace after the trigger point, enter a positive delay. If you want to trace before the trigger point (similar to negative time) enter a negative delay. The logic analyzer is capable of maximum delays of - 2500 seconds to + 2500 seconds. In Transitional mode the maximum delay is determined by the number of transitions of the incoming data. Data may not be displayed at all settings of Time/Div and Delay.

In Glitch mode the maximum delay is 25 seconds, which is controlled by memory and sample period (512 x 50ms). The sample rate is also dependent on the delay setting. It is represented by the following formula:

if delay < 20 ns

Hwdelay = 20 ns (this is an instrument constant)

if delay > 10 ms

Hwdelay = 10 ms

else Hwdelay = delay (delay setting in timing waveforms menu)

Sample period = larger of:

Time/Div ÷ 25 or

absolute value [(delay - Hwdelay) ÷ 256]

If sample period > 50 ms

Then sample period = 50 ms

## Timing Analyzer Measurement Example

---

### Introduction

In this chapter you will learn how to use the timing analyzer by setting up the logic analyzer to simulate a simple timing measurement. Since you may not have the same test circuit available, we will give you the measurement results as actually measured by the logic analyzer,

The exercise in this chapter is organized in a task format. The tasks are ordered in the same way you will most likely use them once you become an experienced user. The steps in this format are both numbered and lettered. The numbered steps state the step objective. The lettered steps explain how to accomplish each step objective. There is also an example of each menu after it has been properly set up.

How you use the steps depends on how much you remember from chapters 1 through 4 of the *Getting Started Guide*. If you can set up each menu by just looking at the menu picture, go ahead and do so. If you need a reminder of what steps you need to perform, follow the numbered steps. If you still need more information about "how," use the lettered steps.

To gain confidence using your logic analyzer, we recommend that you configure the menus as you follow the simulated measurement example up to section "Acquiring the Data." From that section unto the end, you will see the measurement results on the Timing Waveforms screen as if you had the real test circuit connected, and as if you had selected RUN.

---

## Problem Solving with the Timing Analyzer

In this exercise, assume you are designing a dynamic RAM memory (DRAM) controller and you must verify the timing of the row address strobe (RAS) and the column address strobe (CAS). You are using a 4116 dynamic RAM and the data book specifies that the minimum time from when LRAS is asserted (goes low) to when LCAS is no longer asserted (goes high) is 250 ns. You could use an oscilloscope but since the timing analyzer will do just fine when you don't need voltage parametrics you decide to go ahead and use the logic analyzer.

---

## What Am I Going to Measure?

After configuring the logic analyzer and hooking it up to your circuit under test, you will be measuring the time (x) from when the RAS goes low to when the CAS goes high, as shown below.

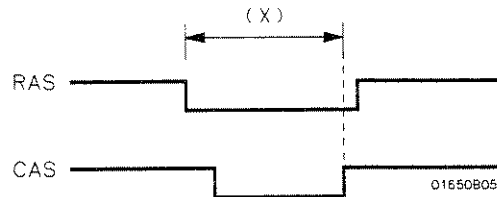

Figure 20-1. RAS and CAS Signals



## How Do I Configure the Logic Analyzer?

In order to make this timing measurement, you must configure the logic analyzer as a timing analyzer. By following these steps you will configure Analyzer 1 as the timing analyzer.

If you are in the System Configuration menu you are in the right place to get started and you can start with step 2; otherwise, start with step 1.

1. Using the field in the upper left corner of the display, get the System Configuration menu on screen.
  - a. Place the cursor on the field in the upper left corner of the display and press SELECT.
  - b. Place the cursor on System and press SELECT.
2. In the System Configuration menu, change Analyzer 1 type to Timing. If analyzer 1 is already a timing analyzer, go on to step 3.
  - a. Place the cursor on the **Type:** \_\_\_ field and press SELECT.
  - b. Place the cursor on Timing and press SELECT.

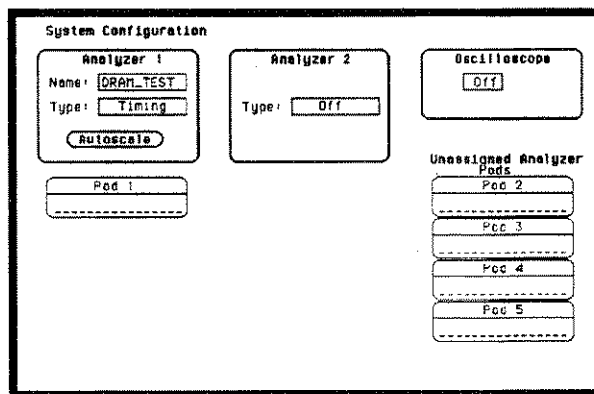

Figure 20-2. System Configuration Menu

3. Name Analyzer 1 "DRAM TEST" (optional)

a. Place the cursor on the **Name:** \_\_\_\_ field of Analyzer 1 and press **SELECT**.

b. With the Alpha Entry pop-up, change the name to "DRAM TEST" (see "How to Enter Alpha Data" in chapter 3 if you need a reminder).

4. Assign pod 1 to the timing analyzer.

a. Place the cursor on the Pod 1 field and press **SELECT**.

b. In the Pod 1 pop-up, place the cursor on Analyzer 1 and press **SELECT**.

## Connecting the Probes

At this point, if you had a target system with a 4116 DRAM memory IC, you would connect the logic analyzer to your system.

Since you will be assigning Pod 1 bit 0 to the RAS label, you hook Pod 1 bit 0 to the memory IC pin connected to the RAS signal. You hook Pod 1 bit 1 to the IC pin connected to the CAS signal.

## Activity Indicators

When the logic analyzer is connected and your target system is running, you will see activity indicators, as shown below, at the right-most end (least significant bits) of the Pod 1 field in the System Configuration menu. This indicates the RAS and CAS signals are transitioning.

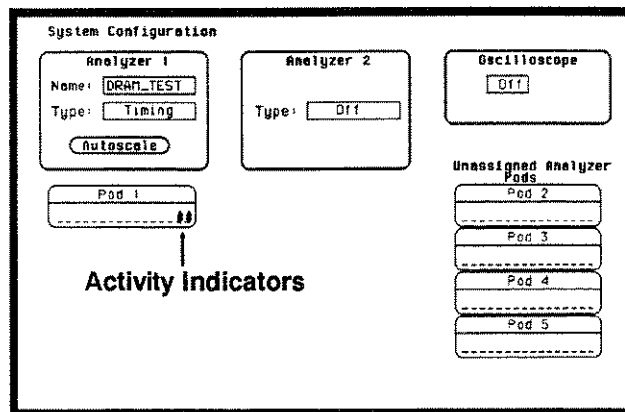

Figure 20-3. Activity Indicators

## Configuring the Timing Analyzer

Now that you have configured the system, you are ready to configure the timing analyzer. You will be:

- Creating two names (labels) for the input signals
  - Assigning the channels connected to the input signals
  - Specifying a trigger condition
1. Display the Timing Format Specification menu.
    - a. Press the FORMAT key on the front panel.
  2. Name two labels, one RAS and one CAS.
    - a. Place the cursor on the top field in the label column and press SELECT.
    - b. Place the cursor on Modify label and press SELECT .

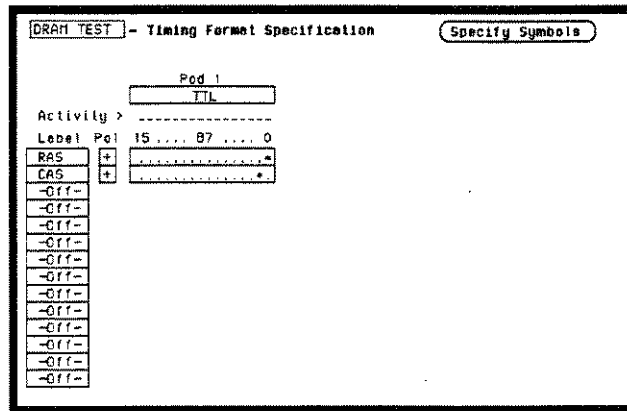

Figure 20-4. Timing Format Specification Menu

- c. With the Alpha Entry pop-up, change the name of the label to RAS.

- d. Name the second label CAS by repeating steps a through c.
3. Assign the channels connected to the input signals (Pod 1 bits 0 and 1) to the labels RAS and CAS respectively.
    - a. Place the cursor on the bit assignment field below Pod 1 and to the right of RAS and press SELECT.
    - b. Any combination of bits may be assigned to this pod; however, you will want only bit 0 assigned to the RAS label. The easiest way to assign bits is to press the CLEAR ENTRY key to un-assign any assigned bits before you start.
    - c. Place the cursor on the period under the 0 in the bit assignment pop-up and press SELECT . This will place an asterisk in the pop-up for bit 0 indicating Pod 1 bit 0 is now assigned to the RAS label. Place cursor on Done and press SELECT to close the pop-up.
    - d. Assign Pod 1 bit 1 to the CAS label by moving the cursor to bit 1 and pressing SELECT.

## Specifying a Trigger Condition

To capture the data and then place the data of interest in the center of the display of the Timing Waveforms menu, you need to tell the logic analyzer when to trigger. Since the first event of interest is when the LRAS is asserted (negative-going edge of RAS), you need to tell the logic analyzer to trigger on a negative-going edge of the RAS signal.

1. Select the Timing Trace menu by pressing the TRACE key.
2. Set the trigger so that the logic analyzer triggers on the negative-going edge of the RAS.
  - a. Place the cursor on the Then find Edge field under the label RAS, then press SELECT.
  - b. Place the cursor on the . (period) in the pop-up and press SELECT once. Pressing SELECT once in this pop-up changes a period to ↓ which indicates a negative-going edge.
  - c. Place the cursor on Done and press SELECT. The pop-up closes and a \$ will be located in this field. The \$ indicates an edge has been specified even though it can't be shown in the HEX base.

The screenshot shows a menu titled "DRAIT TEST - Timing Trace Specification". The menu contains the following fields and options:

- Trace mode:
- Armed by:
- Acquisition mode:
- Label >:
- Base >:
- Find Pattern:
- present for >:
- Then find Edge:

Figure 20-5. Trigger Edge Specified

## Acquiring the Data

Now that you have configured and connected the logic analyzer, you acquire the data for your measurement by pressing the RUN key. The logic analyzer will look for a negative edge on the RAS signal and trigger if it sees one. When it triggers, the display switches to the Timing Waveforms menu.

Note 

From this point in the exercise unto the end, we will give you the measurement results. This way, you will not have to obtain and use an identical circuit.

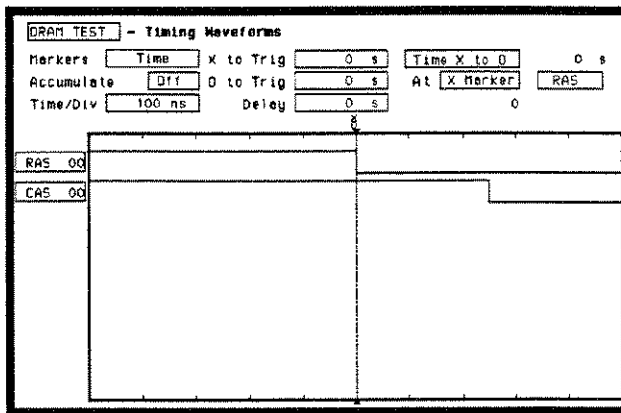

Figure 20-6. Timing Waveforms Menu

The RAS label shows you the RAS signal and the CAS label shows you the CAS signal. Notice the RAS signal goes low at or near the center of the waveform display area (horizontal center).

## The Timing Waveforms Menu

The Timing Waveforms menu differs from the other menus you have used so far in this exercise. Besides displaying the acquired data, it has menu fields that you use to change the way the acquired data is displayed and fields that give you timing answers. Before you can use this menu to find answers, you need to know some of the special symbols and their functions. The symbols are:

- The X and O
- The ▼
- The vertical dotted line

**The X and O** The X and O are markers you use to find your answer. You place them on the points of interest on your waveforms, and the logic analyzer displays the time between the markers. The X and O markers will be in the center of the display when X to trig (ger) and O to trig (ger) are both 0.000 s (see example below).

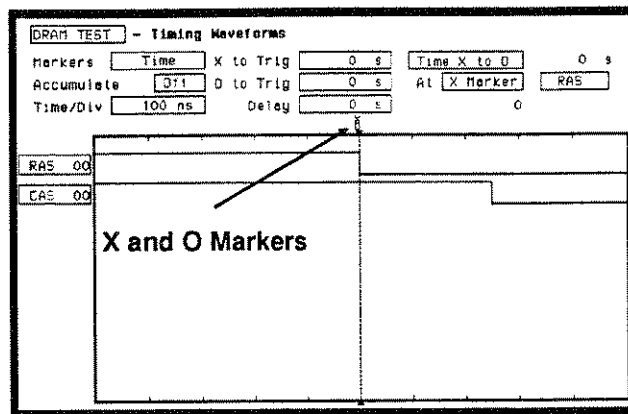

Figure 20-7. X & O Markers



**The ▼** The (inverted triangle) indicates the trace point. Remember, trace point = trigger + delay. Since delay in this example is 0.000 s, you will see the negative-going edge of the RAS signal at center screen under the .

**The Vertical Dotted Line** The vertical dotted line indicates the trigger point you specified in the Timing Trace Specification menu. The vertical dotted line is at center screen under the inverted triangle and is superimposed on the negative-going edge of the RAS signal.

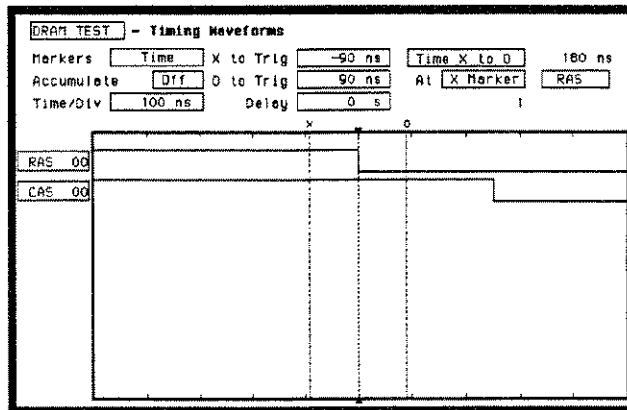

Figure 20-8. Inverted Triangle & Vertical Dotted Line

## Configuring the Display

Now that you have acquired the RAS and CAS waveforms, you need to configure the Timing Waveforms menu for best resolution and to obtain your answer.

### Display Resolution

You get the best resolution by changing the Time/Div to a value that displays one negative-going edge of both the RAS and CAS waveforms. Set the Time/Div by following these steps.



Figure 20-9. RAS and CAS Signals

1. Place the cursor on Time/Div and press SELECT . The Time/Div pop-up appears, showing you the current setting.
2. While the pop-up is present, rotate the KNOB until your waveform shows you only one negative-going edge of the RAS waveform and one positive-going edge of the CAS waveform (see above). In this example 200 ns is best.

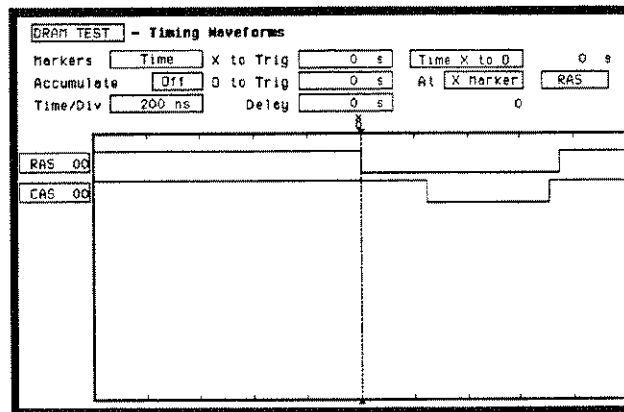

Figure 20-10. Changing Time/Div.

## Making the Measurement

What you want to know is how much time elapses between the time RAS goes low and the time CAS goes high again. You will use the X and O markers to quickly find the answer. Remember, you specified the negative-going edge of the RAS to be your trigger point; therefore, the X marker should be on this edge if X to Trig = 0. If not, follow steps 1 and 2.

1. Place the cursor on the X to Trig field and press SELECT . A pop-up will appear showing you the current time from the X marker to the trigger; however, you don't need to worry about this number now.
2. Rotate the KNOB to place the X marker on the negative-going edge of the RAS waveform and press SELECT . The pop-up closes and displays X to Trig = 0.000 s.
3. Place the cursor on O to Trig and press SELECT . Repeat step 2 except place the O marker on the positive-going edge of the CAS waveform and press SELECT. The pop-up closes and displays O to Trig = 710 ns.

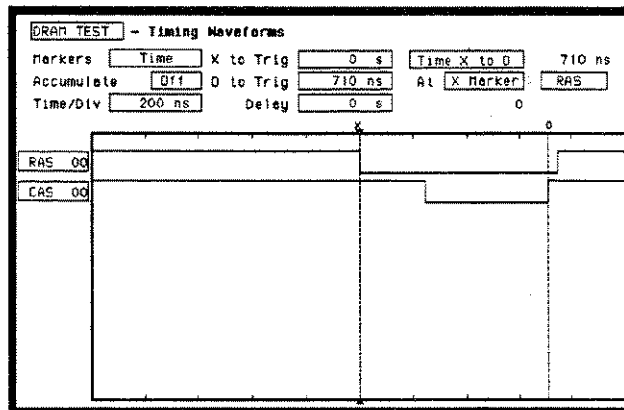

Figure 20-11. Marker Placement

## Finding the Answer

Your answer could be calculated by adding the X to Trig and O to Trig times, but you don't need to bother. The logic analyzer has already calculated this answer and displays it in the Time X to O \_\_\_ field.

This example indicates the time is 710 ns. Since the data book specifies a minimum of 250 ns, it appears your DRAM controller circuit is designed properly.

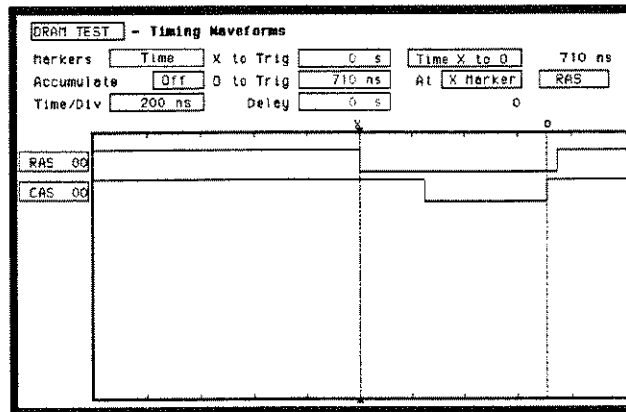

Figure 20-12. Time X to O

---

## Summary

You have just learned how to make a simple timing measurement with the HP 1652B/53B logic analyzer. You have learned to do the following:

- Specified a timing analyzer.
- Assigned pod 1.
- Assigned bits.
- Assigned labels.
- Specified a trigger condition.
- Learned which probes to connect.
- Acquired the data.
- Configured the display.
- Set the Time/Div for best resolution.
- Positioned the markers for the measurement answer.

You have seen how easy it is to use the timing analyzer to make timing measurements that you could have made with a scope. You can use the timing analyzer for any timing measurement that doesn't require voltage parametrics or doesn't go beyond the accuracy of the timing analyzer.

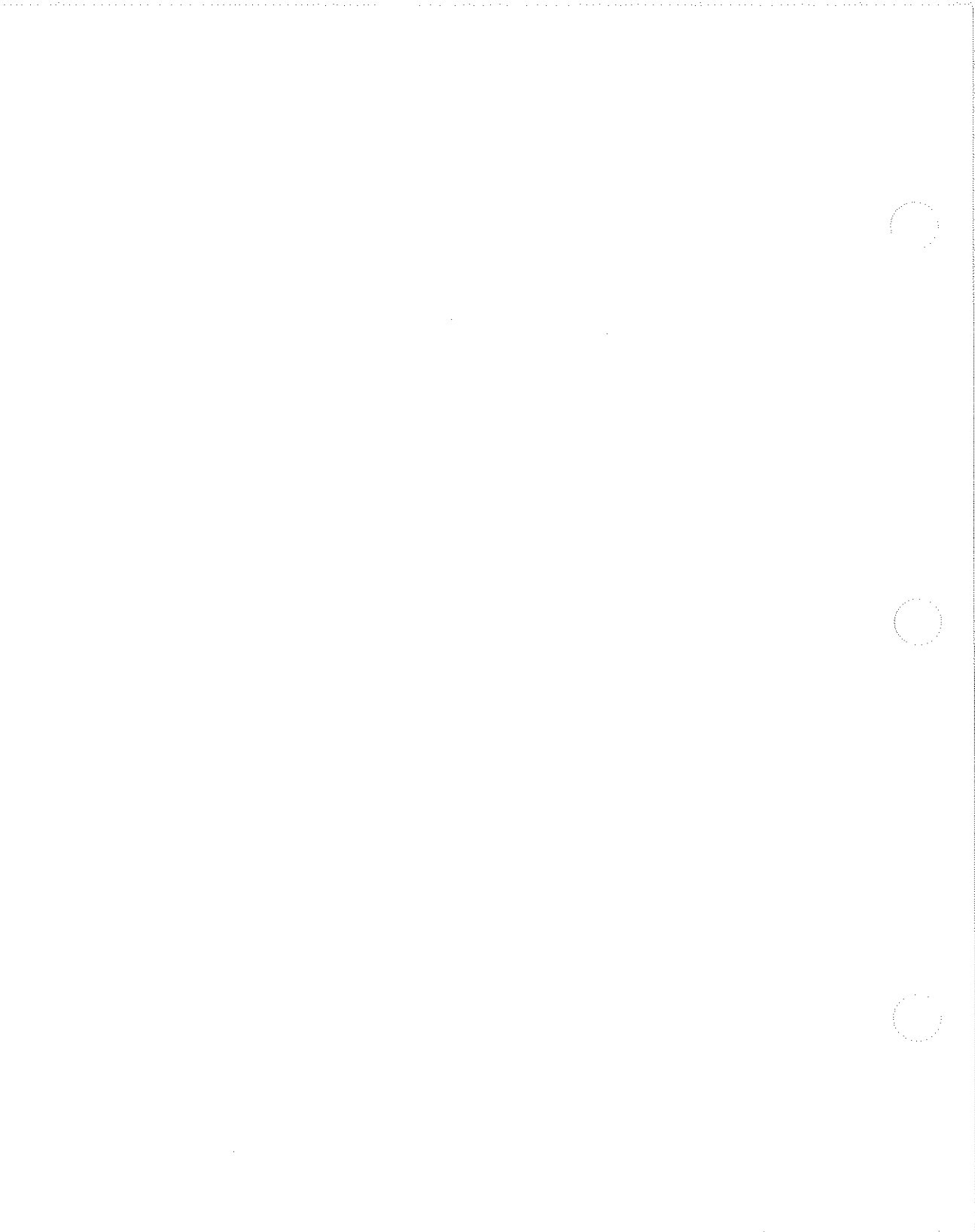

## Timing/State Measurement Example

---

### Introduction

In this chapter you will learn how to use the timing and state analyzers interactively by setting up the logic analyzer to simulate a simple timing/state measurement. Since you may not have the same test circuit available, we will give you the measurement results as actually measured by the logic analyzer.

The exercise in this chapter is organized differently than the exercises in the previous chapters. Since you have already set up both the timing and state analyzers, you should be ready to set them up for this simulated measurement by just looking at the menu pictures.

Any new set-ups in this exercise will be explained in task format steps like the previous chapters.

To gain confidence using your logic analyzer, we recommend that you configure the menus as you follow the simulated measurement example up to section "Acquiring the Data." From that section unto the end, you will see the measurement results on the display screens as if you had the real test circuit connected, and as if you had selected RUN.

---

## **Problem Solving with the Timing/State Analyzer**

In this example assume you have designed a microprocessor-controlled circuit. You have completed the hardware, and the software designer has completed the software and programmed the ROM (read-only memory). When you turn your circuit on for the first time, your circuit doesn't work properly. You have checked the power supply voltages and the system clock, and they are working properly.

Since the circuit has never worked before, you and the software engineer aren't sure if it is a hardware or software problem. You need to do some testing to find a solution.

You also notice the circuit fails intermittently. More specifically, it only fails when the microprocessor attempts to address a routine that starts at address 8930.

---

## **What Am I Going to Measure?**

To see what might be causing the failure, you decide to start where the microprocessor goes to the routine that starts at address 8930. The first thing you check is whether the microprocessor actually addresses address 8930. The next thing you check is whether the code is correct in all the steps in this routine.

Your measurement, then, requires verification of the following:

- Whether the microprocessor addresses location 8930.
- Whether all the addresses within the routine are correct.
- Whether all the data at the addresses in the routine are correct.



If the routine is correct, the state listing displays the following:

```
+ 0000 008930 B03C
+ 0001 008932 61FA
+ 0002 008934 67F8
+ 0003 008936 B03C
+ 0004 00892E 61FA
```

## How Do I Configure the Logic Analyzer?

In order to make this measurement, you must configure the logic analyzer as a state analyzer because you want to trigger on a specific state (8930). You also want to verify that the addresses and data are correct in the states of this routine.

Configure the logic analyzer so that Analyzer 1 is a state analyzer as shown below:

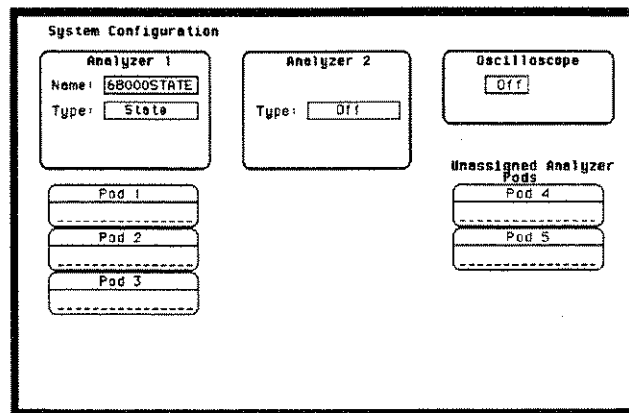

Figure 21-1. System Configuration Menu

## Configuring the State Analyzer

Now that you have configured the system, you are ready to configure the state analyzer. Configure the State Format Specification menu as shown:

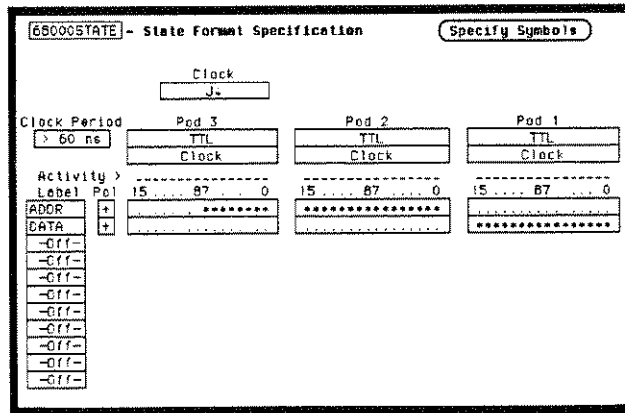

Figure 21-2. State Format Specification Menu

Configure the State Trace Specification menu as shown:

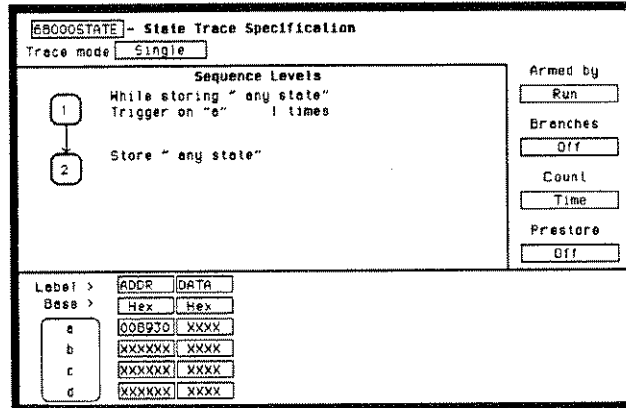

Figure 21-3. State Trace Specification Menu

---

## Connecting the Probes

At this point, if you had a target system with a 68000 microprocessor, you would connect the logic analyzer to your system. Since you will be assigning labels ADDR and DATA, you will hook the probes to your system accordingly:

- Pod 1 probes 0 through 15 to the data bus lines D0 through D15.
- Pod 2 probes 0 through 15 to the address bus lines A0 through A15.
- Pod 3 probes 0 through 7 to the address bus lines A16 through A23.
- Pod 1, CLK (J clock) to the address strobe (LAS).

---

## Acquiring the Data

Since you want to capture the data when the microprocessor sends address 8930 on the bus, you press the RUN key to arm the state analyzer. If the microprocessor sends address 8930, it will trigger the state analyzer and switch the display to the State Listing menu.

**Note**



From this point in the exercise unto the end, we will give you the measurement results. This way, you will not have to obtain and use an identical circuit.

---

## Finding the Problem

You look at this listing to see what the data is in states + 0000 through + 0004. You know your routine is five states long.

The 68000 does address location 8930, so you know that the routine is addressed. Now you need to compare the state listing with the following correct addresses and data:

```
+ 0000 008930 B03C
+ 0001 008932 61FA
+ 0002 008934 67F8
+ 0003 008936 B03C
+ 0004 00892E 61FA
```

As you compare the state listing (shown below) with the above data you notice the data at address 8932 is incorrect. Now you need to find out why.

Label	ADDR	DATA
Base	Hex	Hex
-0007	0088CA	00FF
-0006	0088CC	6730
-0005	0088CE	4BE7
-0004	0088FE	4E7E
-0003	008900	3000
-0002	0004F4	0000
-0001	0004F6	8930
+0000	008930	B03C
+0001	008932	00FF
+0002	008934	67F8
+0003	008936	B03C
+0004	00892E	61FA
+0005	008930	B03C
+0006	0004F4	0000
+0007	0004F6	8930
+0008	00892A	4EFA

Figure 21-4. Incorrect Data

Your first assumption is that incorrect data is stored to this memory location. Assume this routine is in ROM since it is part of the operating system for your circuit. Since the ROM is programmed by the software designer, you have the software designer verify whether or not the data at address 8932 is correct. The software designer tells you that the data is correct. Now what do you do?

Now it's time to look at the hardware to see if it is causing incorrect data when the microprocessor reads this memory address. You decide you want to see what is happening on the address and data buses during this routine in the time domain.

In order to see the time domain, you need the timing analyzer.

---

## **What Additional Measurements Must I Make?**

Since the problem exists during the routine that starts at address 8930, you decide you want to see the timing waveforms on the address and data bus when the routine is running. You also want to see the control signals that control the read cycle. You will then compare the waveforms with the timing diagrams in the 68000 data book.

Your measurement, then, requires verification of the following:

- Correct timing of the control signals.
- Stable addresses and data during the memory read.

The control signals you must check are listed below:

- System clock.
- Address strobe (AS).
- Lower and upper data strobes (LDS and UDS).
- Data transfer acknowledge (DTACK).
- Read/write (R/W).

## How Do I Re-Configure the Logic Analyzer?

In order to make this measurement, you must re-configure the logic analyzer so Analyzer 2 is a timing analyzer. You leave Analyzer 1 as a state analyzer since you will use the state analyzer to trigger on address 8930.

Configure the logic analyzer so Analyzer 2 is a timing analyzer as shown:

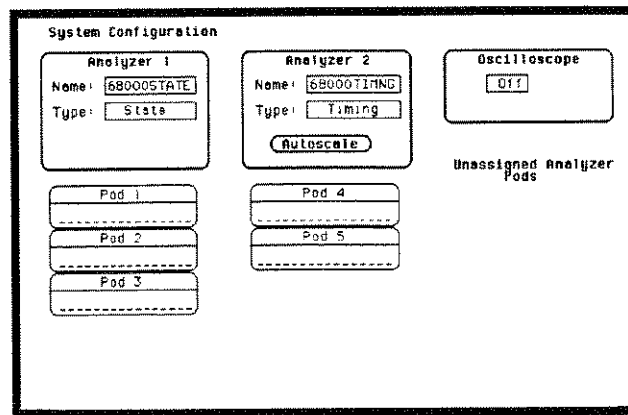

Figure 21-5. System Configuration Menu

## Connecting the Timing Analyzer Probes

At this point you would connect the probes of pods 4 and 5 as follows:

- Pod 4 bit 0 to address strobe (AS).
- Pod 4 bit 1 to the system clock.
- Pod 4 bit 2 to low data strobe (LDS).
- Pod 4 bit 3 to upper data strobe (UDS).
- Pod 4 bit 4 to the read/write (R/W).
- Pod 4 bit 5 to data transfer acknowledge (DTACK).
- Pod 5 bits 0 through 7 to address lines A0 through A7.
- Pod 5 bits 8 through 15 to data lines D0 through D7.

## Configuring the Timing Analyzer

Now that you have configured the system, you are ready to configure the timing analyzer. Configure the Timing Format Specification menu as shown:

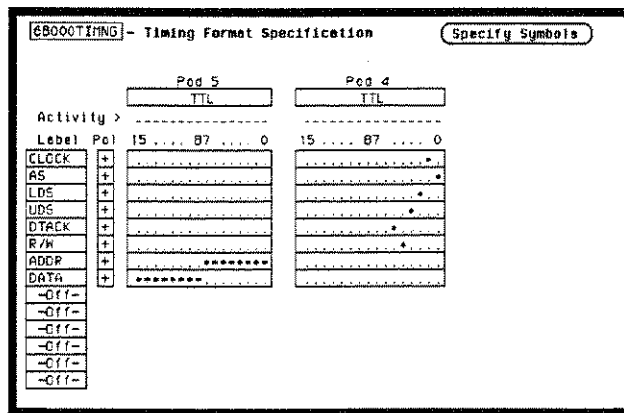

Figure 21-6. Timing Format Specification Menu

Configure the Timing Trace Specification as shown:

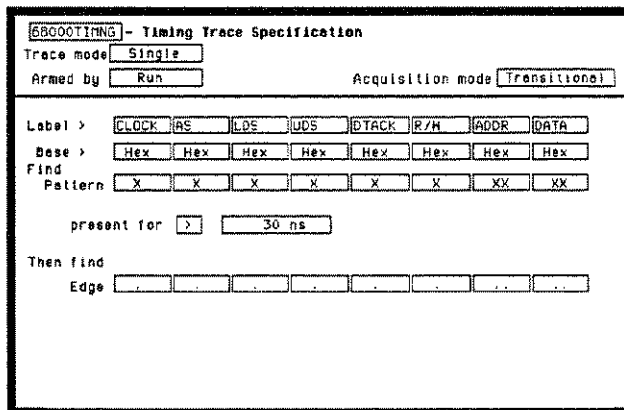

Figure 21-7. Timing Trace Specification Menu

## Setting the Timing Analyzer Trigger

Your timing measurement requires the timing analyzer to display the timing waveforms present on the buses when the routine is running. Since you triggered the state analyzer on address 8930, you want to trigger the timing analyzer so the timing waveforms can be time correlated with the state listing.

To set up the logic analyzer so that the state analyzer triggers the timing analyzer, perform these steps:

1. Display the Timing Trace Specification menu.
2. Place the cursor on the Armed by \_\_\_\_ field and press SELECT.
3. Place the cursor on the 68000STATE option in the pop-up and press SELECT.

Your timing trace specification should match the menu shown:

State Analyzer  
Arms Timing  
Analyzer

The screenshot shows a menu titled "68000TIMING - Timing Trace Specification". The "Trace mode" is set to "Single" and the "Armed by" field is set to "68000STATE". The "Acquisition mode" is set to "Transitional". Below this, there are fields for "Label", "Base", and "Find Pattern". The "Label" field contains "CLOCK", "AS", "LDS", "UDS", "DTACK", "R/M", "ADDP", and "DATA". The "Base" field contains "Hex", "Hex", "Hex", "Hex", "Hex", "Hex", "Hex", and "Hex". The "Find Pattern" field contains "X", "X", "X", "X", "X", "X", "XX", and "XX". There is a "present for" field set to "30 ns". At the bottom, there is a "Then find" section with an "Edge" field.

Figure 21-8. Armed by 68000 STATE



## Time Correlating the Data

In order to time correlate the data, the logic analyzer must store the timing relationships between states. Since the timing analyzer samples asynchronously and the state analyzer samples synchronously, the logic analyzer must use the stored timing relationship of the data to reconstruct a time correlated display.

To set up the logic analyzer to keep track of these timing relationships, turn on a counter in the State Trace Specification menu. The following steps show you how:

1. Display the State Trace Specification menu.
2. Place the cursor in the field just below Count on the right side of the display and press SELECT.
3. Place the cursor on the Time option and press SELECT. The counter will now be able to keep track of time for the time correlation.

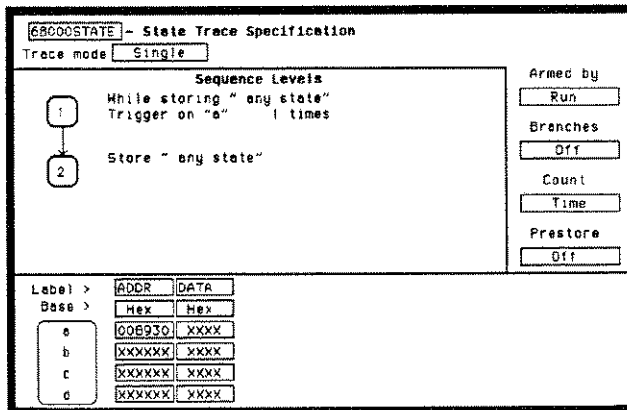

Figure 21-9. Count Set to Time

## Re-acquiring the Data

After you connect the probes of pods 4 and 5 to your circuit, all you have to do is press RUN. When the logic analyzer acquires the data it switches the display to the State Listing menu unless you switched one of the other menus to the timing analyzer after reconfiguring the State Trace menu. Regardless of which menu is displayed, change the display to the Mixed Mode.

## Mixed Mode Display

The Mixed mode display shows you both the State Listing and Timing Waveforms menus simultaneously. To change the display to the Mixed Mode:

1. Place the cursor on the field in the upper left corner of the display and press SELECT.
2. Place the cursor on Mixed Mode and press SELECT. You will now see the mixed display as shown:

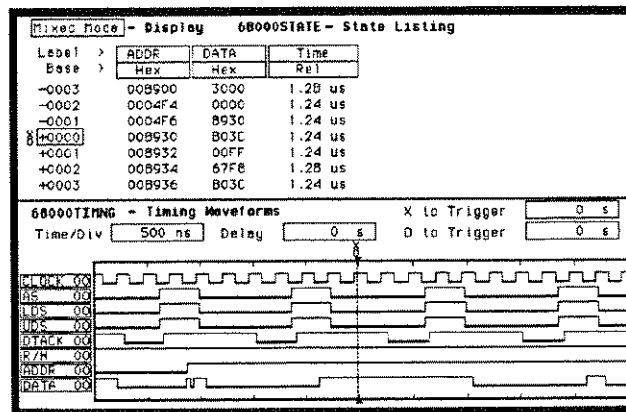

Figure 21-10. Mixed Mode Display

## Interpreting the Display

In the Mixed Mode display the state listing is in the top half of the screen and the timing waveforms are in the lower half. The important thing to remember is that you time correlated this display so you could see what is happening in the time domain during the faulty routine.

Notice that the trigger point in both parts of the display is the same as it was when the displays were separate. The trigger in the state listing is in the box containing + 0000 and the trigger of the timing waveform is the vertical dotted line.

As you look at the mixed display, you notice nothing wrong except the data at address 8932 is incorrect. However, you are seeing only one bit each of the address and the data. To see all the data and addresses in the timing waveform part of the display, you must overlap them.

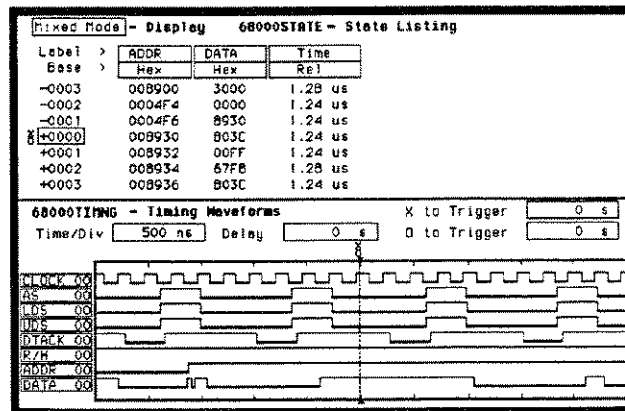

Figure 21-11. Interpreting the Display

## Overlapping Timing Waveforms

Since you see nothing wrong with the timing waveforms so far, you think unstable data may be on the data lines during the read cycle. In order to see unstable data, you must be able to see all the data lines during the read and look for transitions. Overlapping the waveforms allows you to do this. To overlap waveforms, follow these steps:

1. Place the cursor on the 00 of the ADDR 00 label and press SELECT. The following pop-up opens in which you specify the bit or bits of the address bus you want to overlap.

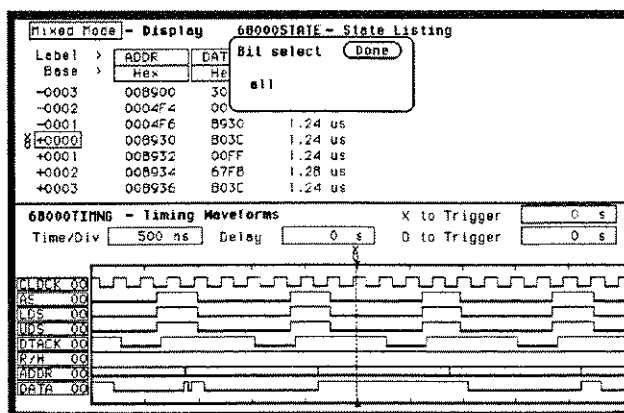

Figure 21-12. Overlapping Timing Waveforms

2. Rotate the KNOB until all is displayed and press SELECT. All the address bits will be overlapped on one line.
3. Repeat step 2 except overlap the data bits.



---

## Summary

You have just learned how to use the timing and state analyzers interactively to find a problem that first appeared to be a software problem, but actually was a hardware problem.

You have learned to do the following:

- Trigger one analyzer with the other.
- Time correlate measurement data.
- Interpret the Mixed mode display.
- Overlap timing waveforms.

If you have an HP 1653B, you do not have enough channels to simultaneously capture all the data for a 68000. But, since you probably aren't working with 16-bit microprocessors, this exercise is still valuable because it shows you how to make the same kind of measurement on an eight-bit microprocessor.

## The Oscilloscope

---

### Introduction

This chapter introduces the oscilloscope and gives an overview of the main menus that you will use on your oscilloscope. Also included are scope menu maps. The purpose and functions of each menu are explained in detail in the following chapters.

- Chapter 23 explains the Channel Menu.
- Chapter 24 explains the Trigger Menu.
- Chapter 25 explains the Waveforms Menu.
- Chapter 26 explains Mixed Mode Displays.
- Chapter 27 gives you a basic mixed mode measurement example.

An actual signal from the compensation signal output is used throughout most of these chapters to better illustrate how to use the different oscilloscope menus. If you need an introduction to oscilloscopes, refer to *Feeling Comfortable with Digitizing Oscilloscopes*.

---

### The Scope (An Overview)

The oscilloscope in the HP 1652B/1653B Logic Analyzer is a 2 channel, 400 megasample/second, 100 MHz single-shot and repetitive (repetitive single-shot) bandwidth scope. It is turned on/off from the System Configuration menu with the Channel, Trigger and Waveforms menus accessed from front panel keys. The scope can be armed by the analyzer or an external BNC.

---

### Scope Menu Maps

The scope menu maps show you the fields and the available options of each field within the three menus. The menu maps will help you get an overview of each menu as well as provide a quick reference of what each menu contains. Waveform selection is available in all main menus and is shown in the Waveform Selection Menu Map.

## The Channel Menu Map

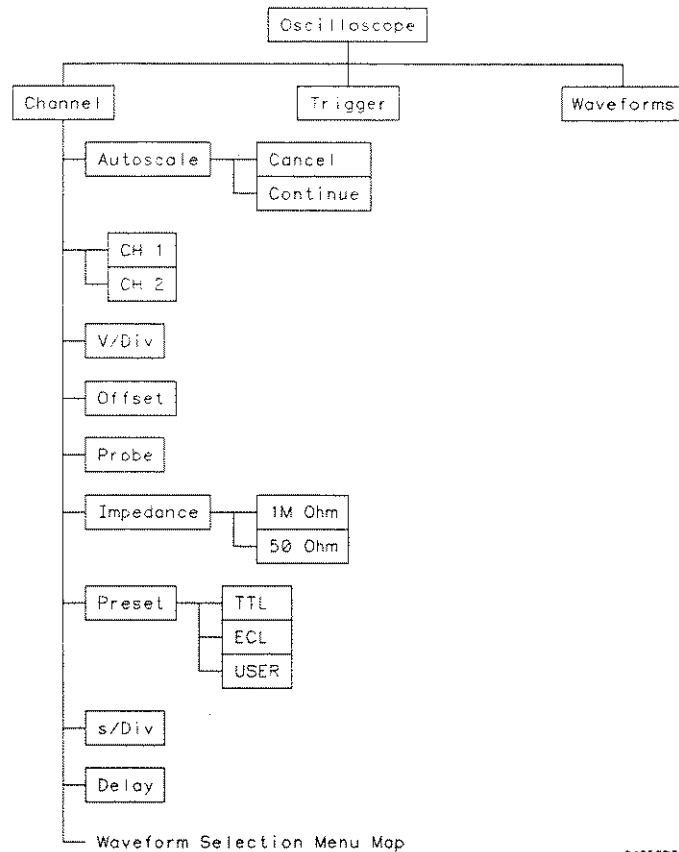

01652B02



# The Trigger Menu Map

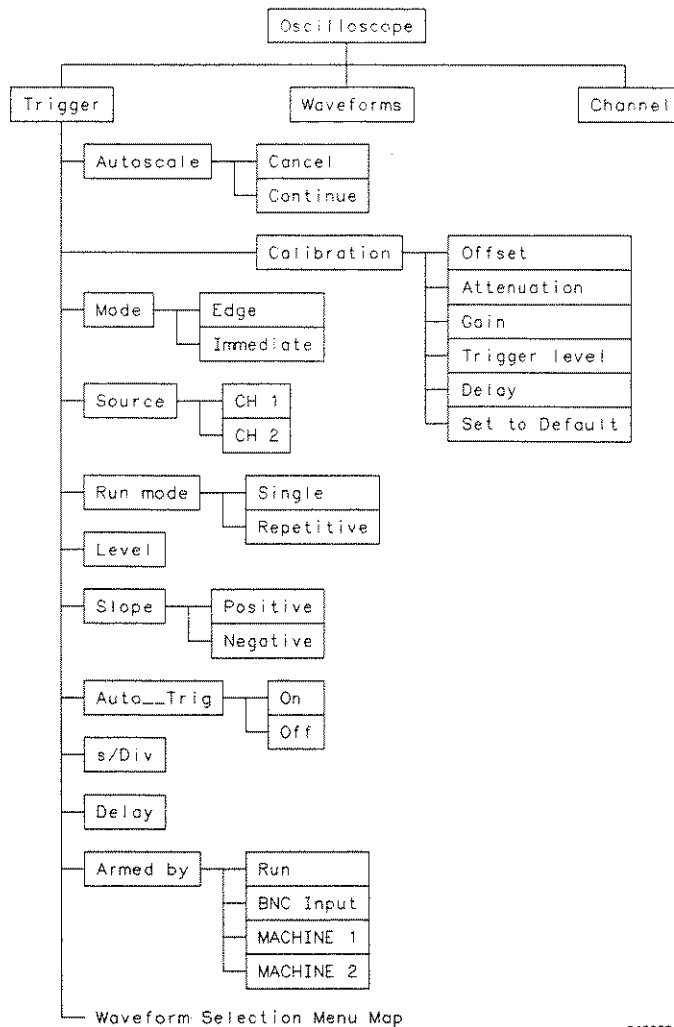

01652803

# The Waveforms Menu Map

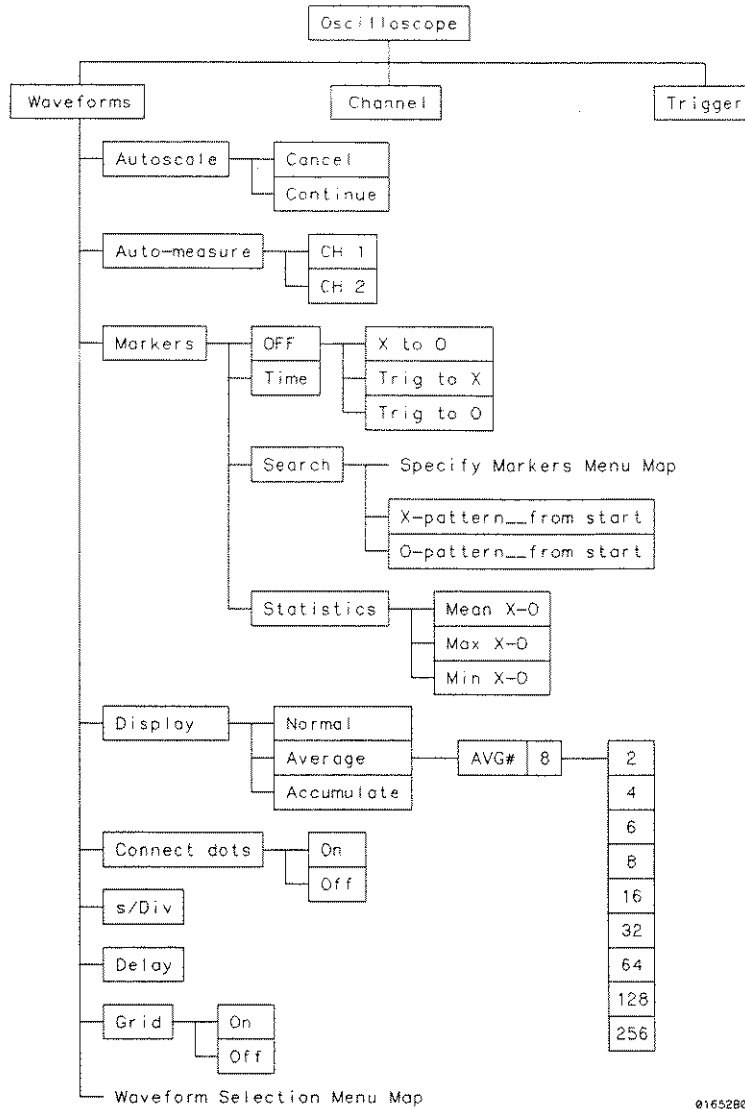

01652B01

## Waveform Selection Menu Map

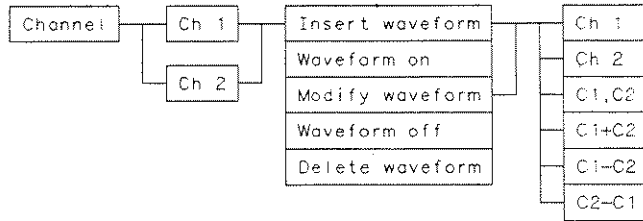

01652804

## Specify Markers Menu Map

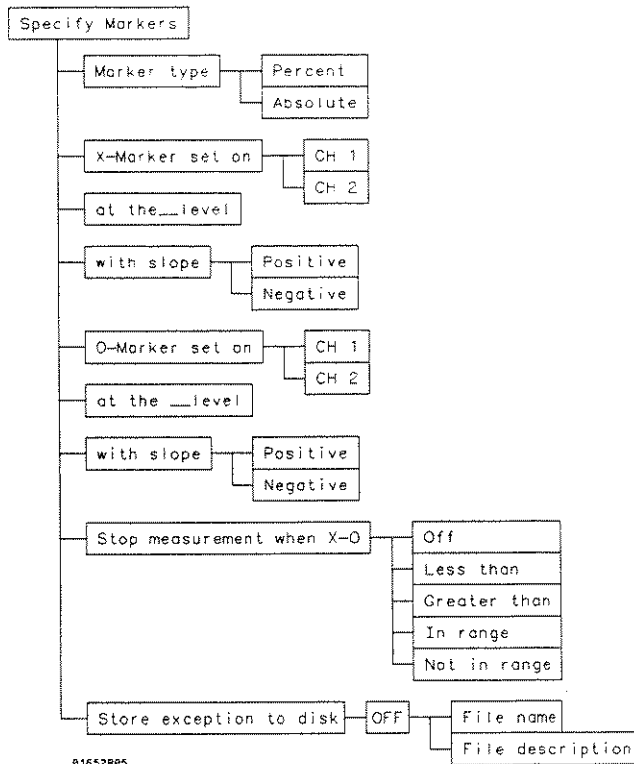

01652885

---

## Menu Overview

The oscilloscope menus are:

- Channel
  - Timebase Function
  - Autoscale Function
- Trigger
  - Calibration Function
- Waveforms
  - Auto-measure Function
  - Marker Measurement Function

An illustration for each main menu is given at the beginning of each chapter. As new menu fields and pop-up fields appear, a new illustration will be shown. Use these illustrations to help in identifying the field being discussed.

The **Channel menu** (CHAN key) controls the vertical sensitivity, offset, probe attenuation, and input impedance of both input channels. In addition, the timebase functions of seconds/division (s/Div) and delay are controlled in this menu. The s/Div and delay can be controlled in the other main menus as well, but will be defined in the Channel Menu chapter.

Like the timebase functions, the autoscale function is available in all main menus, but is defined in the Channel Menu chapter.

The **Trigger menu** (TRIG key) controls the selection of trigger modes, input source, level, slope, and auto-trigger. Selection of the arming source and run mode is also controlled in this menu.

Access to the oscilloscope calibration menu is done through this menu. When the calibration field is selected, new menus will appear that guide you through the calibration process. The calibration procedure is found in Appendix D.

The **Waveforms menu** (DISPLAY key) controls the display mode, connect the dots, and grid on/off. Also included in this menu is the Auto-measure function and Marker measurement criterion set-up.

At power up, the System Configuration menu defaults the oscilloscope to on. All main oscilloscope menus can be selected from the front panel keys.



## Channel Menu

### Introduction

The Channel menu controls the vertical sensitivity, offset, probe attenuation factor, and input impedance of all input channels, as well as the probe attenuation factor. The Channel menu also allows you to preset vertical sensitivity, offset, and trigger level for ECL and TTL logic levels. The default Channel menu is shown below.

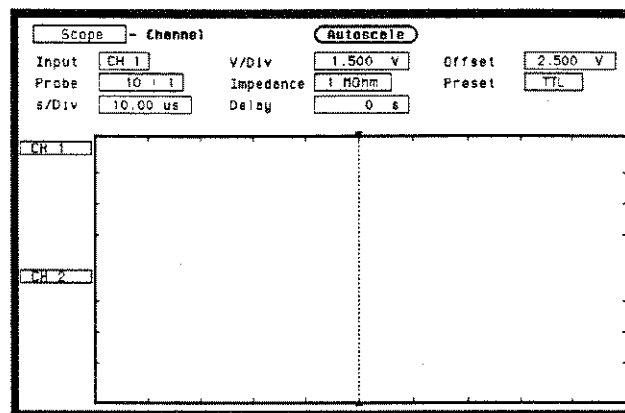

Figure 23-1. Channel Menu

### Channel Menu Fields

**Input Field** The **Input** field is located on the left side of the top row of fields. It selects the input source for the channel parameters displayed on the Channel Specification menu.

The default **Input** field selection is channel 1. When you select the **Input** field, it will toggle from CH 1 to CH 2.

**V/Div Field** The V/Div field is located in the middle of the top row of fields. It sets the vertical sensitivity of the channel selected in the Input field. Vertical sensitivity determines the size of a waveform displayed on screen and is measured in volts/division. Each waveform display is divided into four vertical divisions. The divisions are marked by small tick marks at the left and right sides of the waveform display.

When the V/Div field is selected, a pop-up will appear which allows the vertical sensitivity to be changed by turning the knob. See upper pop-up in figure 23-2.

As the vertical sensitivity is changed, the signal expands and compresses in both directions vertically from the center of the display. When probe field is set to 10:1, the vertical sensitivity will change in a 1-2-5 sequence from 150 mV/div to 100 V/div.

Vertical sensitivity can also be entered from the keypad. A Numeric Entry pop-up will appear when the first numeric key is touched. See lower pop-up in figure 23-2.

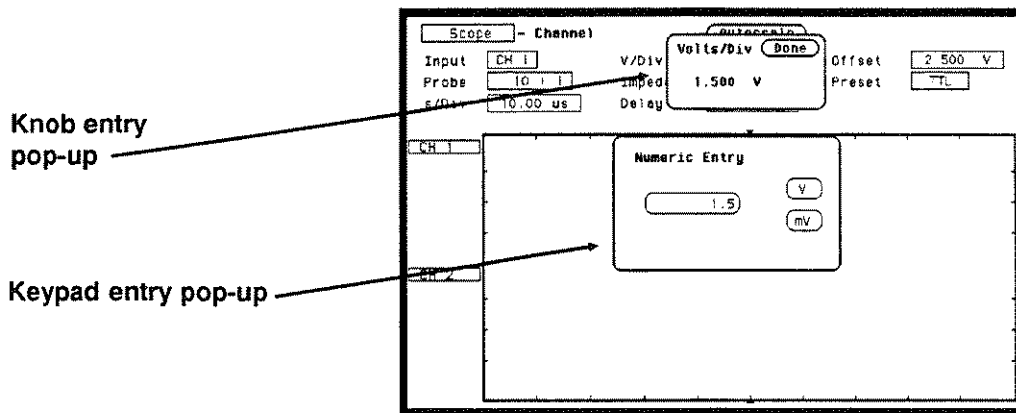

**Figure 23-2. V/Div Entry Pop-ups**

Any value from 150 mV/div to 100 V/div can be entered from the keypad. The vertical sensitivity value can be set to the two most significant digits. For example, if you entered a value of 154 mV, the value would be rounded to 150 mV.



The default value for the V/Div field is 1.5 V (TTL preset value).

**Note** 

If acquisitions have been stopped, vertical sensitivity changes will not be reflected on the waveform until RUN is touched and the next acquisition is displayed.

**Offset Field**

The **Offset** field is located on the right side of the top row of fields. Offset is the voltage represented at the center vertical tick mark in the waveform display. Offset is a dc voltage that is added or subtracted from the input signal so that the waveform can be shown centered on the waveform display.

When the Offset field is selected, a pop-up will appear and the offset value of the channel selected in the Input field can be changed by turning the knob. See the upper pop-up in figure 23-3.

As offset is changed, and after a run, the position of the waveform moves up or down on the waveform display. Offset works similar to the vertical position control of an analog oscilloscope, but offset is calibrated.

Valid offset values can also be entered from the keypad. A Numeric Entry pop-up will appear when the first numeric key is touched. See the lower pop-up in figure 23-3.

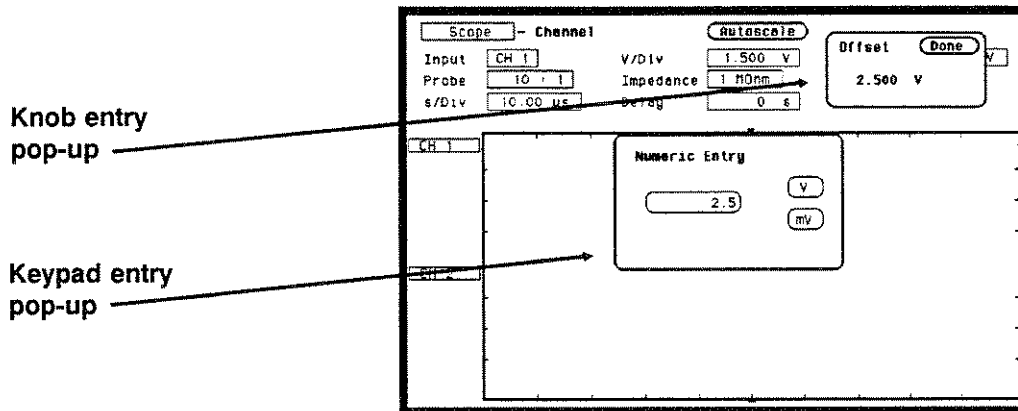

Figure 23-3. Offset Voltage Entry Pop-ups

The default value for the Offset field is 2.5 V (TTL preset value). Offset range and resolution is dependent on vertical sensitivity and input impedance. See table 23-1.

**Note** 

If acquisitions have been stopped, offset changes will not be reflected on the waveform until RUN is touched and the next acquisition is displayed.

**Probe Field**

The **Probe** field is located on the left side of the middle row of fields. It sets the probe attenuation factor for the channel selected. The probe attenuation factor can be set from 1:1 to 1000:1 in increments of 1. When the Probe field is selected, a pop-up will appear and the probe attenuation factor can be changed by turning the knob. See the upper pop-up in figure 23-4.

Probe attenuation can also be entered by using the keypad. An Integer Entry pop-up will appear when the first key is touched. See the lower pop-up in figure 23-4.

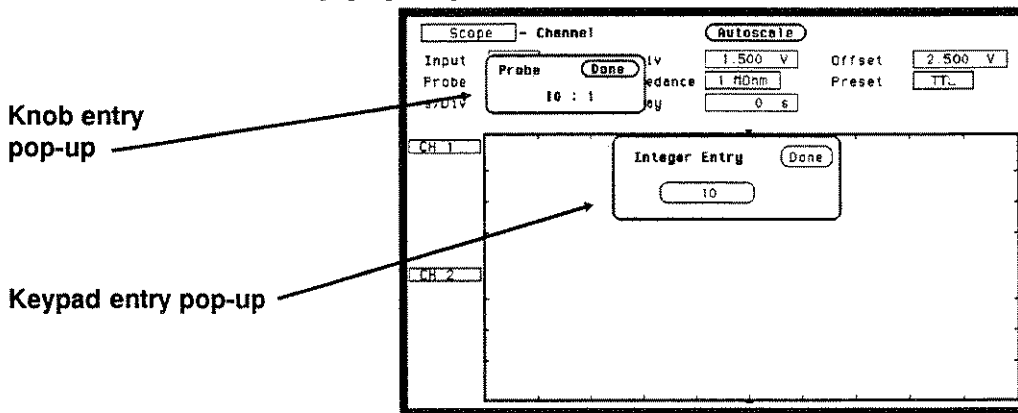

**Figure 23-4. Probe Attenuation Entry Pop-ups**

When you select a probe attenuation factor, the actual sensitivity at the input does not change; The voltage values used on the display (V/div, offset, marker values, trigger level, automatic measurements) are adjusted to reflect the attenuation factor.

The default value for the Probe field is 10:1 for 10:1 divider probes.

### Impedance Field

The **Impedance** field is located in the middle of the middle row of fields. It sets the input impedance for the channel selected. When the **Impedance** field is selected, the input impedance will toggle between 1 M $\Omega$  (dc) and 50  $\Omega$  (dc). No pop-up keypad is available for this field. The default value for the **Impedance** field is 1 MOhm.

### Preset Field

The **Preset** field is located on the right side of the middle row of fields. It automatically sets offset, V/div, and trigger level values to properly display TTL and ECL logic levels.

When you select the **Preset** field, a pop-up will appear as shown in figure 23-5. Rotate the knob until the proper field is highlighted, then touch the select key.



**Figure 23-5. Preset Field Pop-up**

When you select TTL or ECL, the following values are set:

PARAMETER	PRESET VALUE	
	ECL	TTL
V/DIV	500MV	1.5V
OFFSET	-1.0V	2.5V
TRIG LEVEL	-1.300V	1.620V

01652M01

**Table 23-1. Preset Value**

When any of the values listed in table 23-1 are changed from the preset value, the **Preset** field will change to User defined. If User is selected from the pop-up, no values will be changed.

The default value for the **Preset** field is TTL.

## Waveform Selection

This section will show you how to insert, modify, and delete input channels on the waveform display and how to perform waveform math and overlay functions. Any of these operations can be performed from any of the oscilloscope main menus.

The channel label fields to the left of the waveform display shows the input channels that are being displayed. Figure 23-6 shows the default setting which displays CH 1 and CH 2 selected.

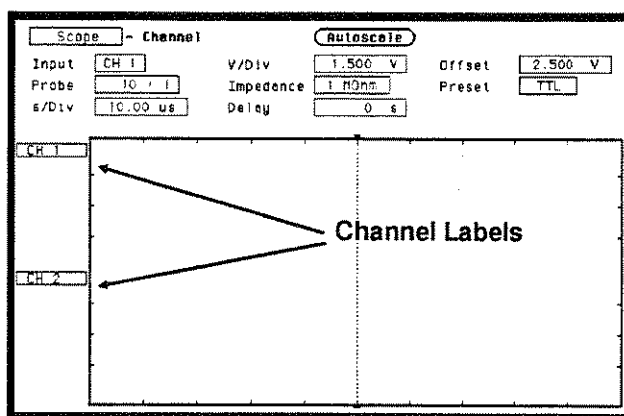

Figure 23-6. Channel Label Fields

## Waveform Selection Setup

Set up the oscilloscope as described below. This instrument setup will be used throughout the remainder of this example.

### Connecting the Equipment

Connect a BNC tee adapter and BNC cables to the oscilloscope as shown below.

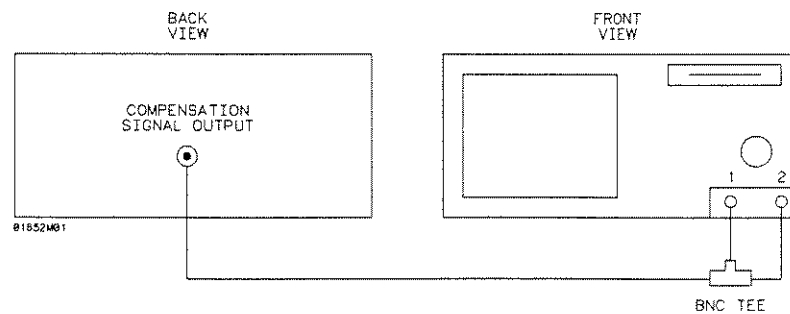
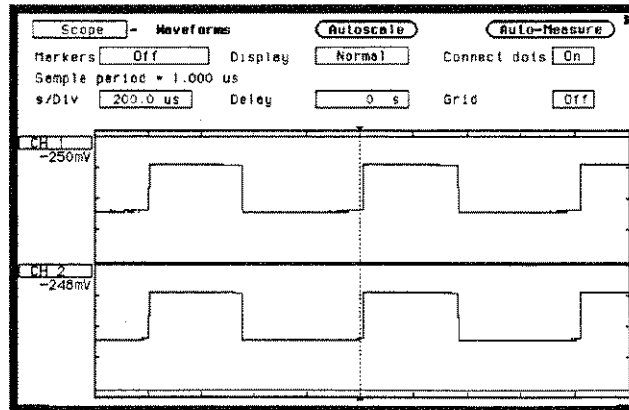

Figure 23-7. Compensation Signal Hookup

### Setting Up the Oscilloscope

1. Turn the power on to the instrument.
2. From the System Configuration menu, turn the oscilloscope on and all analyzers off.
3. Touch CHAN key. From the default oscilloscope Channel menu, make the following changes:
  - CH 1 Probe field to 1:1
  - CH 1 Impedance field to 50 Ohms
  - CH 2 Probe field to 1:1
  - CH 2 Impedance field to 50 Ohms
4. Select Autoscale and set to Continue.
5. Touch the TRIG key to display the Trigger menu.

6. Select the **Run mode** field and toggle to **Repetitive**.
7. Select the **Waveforms** menu and toggle **Connect dots** field to **On**.  
The displayed waveforms should now look like figure 23-8.

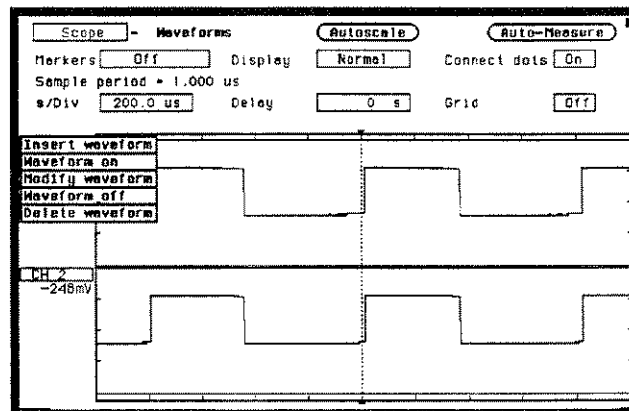

**Figure 23-8. Compensation Signal Waveforms**

### Turning the Waveforms On/Off

The waveform selection defaults to Waveform on for channel 1 and channel 2.

1. Select the CH 1 input label. A waveform selection pop-up appears as shown in figure 23-9.



**Figure 23-9. Waveform Selection Pop-up menu**

2. With Waveform on, the channel 1 signal will be displayed in the waveform display. Select **Waveform off**. Channel 1 signal is now gone, and the channel label has changed to **-off-**. See figure 23-10.

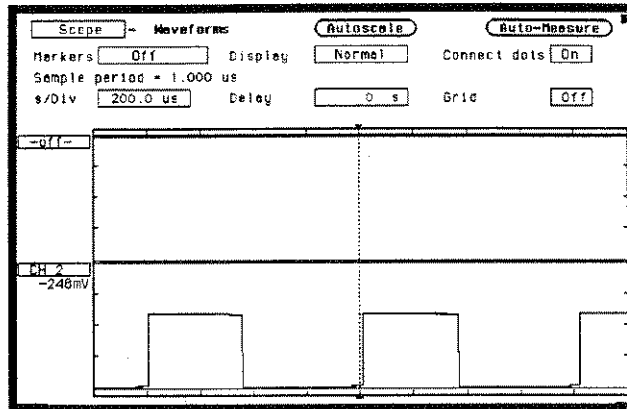

Figure 23-10. Channel 1 Turned Off

3. To turn channel 1 waveform back on, select the channel label field, then select **Waveform on**.

### Insert/Delete Waveforms

When a signal is inserted into the waveform display, its label field and waveform will always be displayed directly below the highlighted label and corresponding waveform.

1. Select CH 1 label field, then select **Insert waveform**. A channel mode pop-up will appear. See figure 23-11.

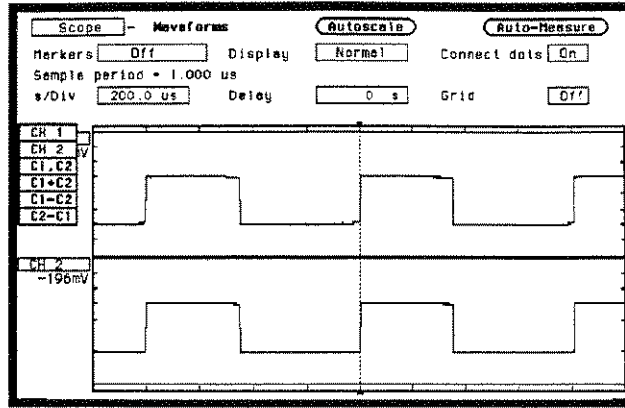

Figure 23-11. Channel Mode Pop-up

2. Select CH 2. Notice that the second CH 2 was inserted directly below CH 1.
3. To delete CH 2 from the channel label list, select CH 2.
4. Select **Delete waveform**. CH 2 is now removed and you are back to the start.

## Modify Waveforms

When you modify a waveform, you select the channel label to be modified and replace it with a selection from the channel mode pop-up.

1. Select CH 1 label field, then select **Modify waveform**.
2. Select CH 2 from the channel mode pop-up, then touch the **RUN** key. Notice that CH 1 has been replaced with CH 2. Channel 2 is now being displayed twice.
3. Select CH 2 label field (the same one just modified), then select **Modify waveform**.
4. Select CH 1 from the channel mode pop-up, then touch the **RUN** key. Now you are back to the start.



## Overlay (C1,C2)

What we have been displaying so far in this section are examples using just single channels. These examples display a single input channel in each waveform display.

Suppose you wanted to take the signal from CH 1 and compare it to the signal from CH 2. The easiest way to do this would be to put both waveforms on the same waveform display, or overlay the waveforms.

1. Select CH 1, then select **Modify waveform**. Select C1,C2, then touch the **RUN** key. CH 2 is now overlaid on CH 1 in the top waveform display.
2. Select the s/Div field and change the sweep speed to 5 ns/div. This will allow us to see the overlaid waveforms easier. The display should now look like the figure below.

**Note** 

To get a better display of the two waveforms overlaid, use an extra long cable on one of the inputs. This will delay one waveform.

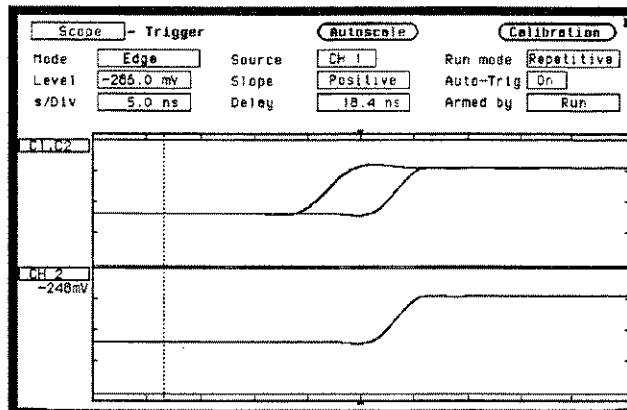

Figure 23-12. Overlay Waveform Display

## Waveform Math (C1 + C2), (C1-C2)

Suppose you wanted to take the signal from CH 2 and add it to or subtract it from the signal from CH 1. Let's try subtracting CH 2 from CH 1.

1. Select **C1,C2** label field, then select **Modify waveform**.
2. Select **C1-C2** field. With the s/Div still set at 5 ns, the waveform display should look like the figure below.

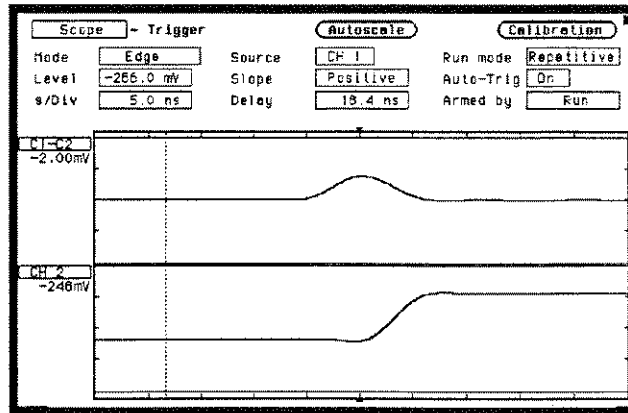

Figure 23-13. C1-C2 Waveform Display

## Timebase Functions

The *s/Div* and Delay timebase functions control the horizontal display on the oscilloscope. The **Delay** and *s/Div* fields are located in the bottom row of fields and are displayed on all oscilloscope main menus.

### Instrument Setup

The instrument should already be set up from the previous exercise. If you need to reset the menu fields, refer to that exercise or select the **Autoscale** field and set to **Continue**. Your screen should look like the figure below.

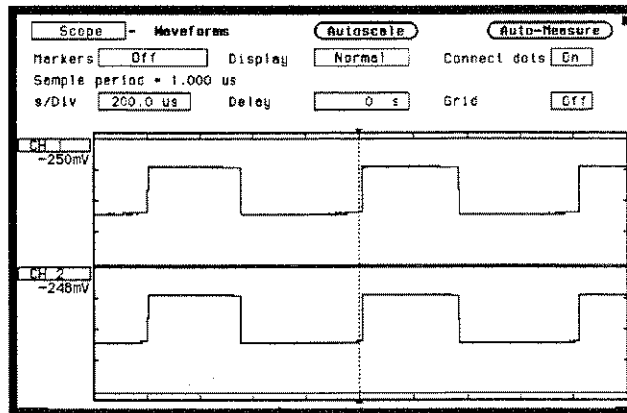
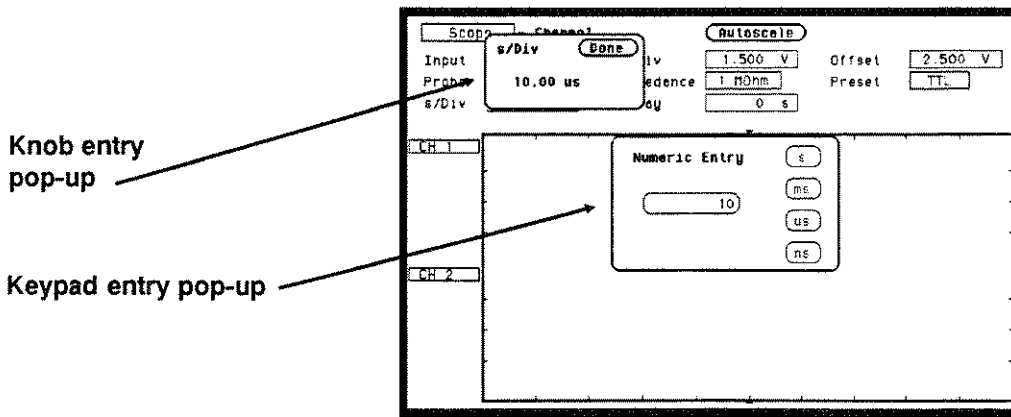

Figure 23-14. Compensation Signal Waveform

**s/Div Field** The *s/Div* field sets the sweep speed or time scale on the horizontal axis of the display and is measured in seconds/division. The display is divided into 10 horizontal divisions. The divisions are marked by small tick marks at the top and bottom of the waveform display.

When the *s/Div* field is selected, a pop-up will appear and the sweep speed of the channel selected in the Input field can be changed by turning the knob. See the upper pop-up in figure 23-15.



**Figure 23-15. s/Div Entry Pop-ups**

As the sweep speed is changed, the signal expands and compresses in both directions from the center of the display. As you turn the knob, the sweep speed changes in a 1-2-5 sequence from 5 ns/Div to 5 s/Div.

Sweep speed can also be entered from the Numeric Entry pop-up. The pop-up will appear when the first numeric key is touched. See the lower pop-up in figure 23-15.

Any value from 5 ns/Div to 5 s/Div can be entered from the keypad. Sweep speed can be set to three-digit resolution. For example, if you entered a value of 15.45 ns, the value would be rounded up to 15.5 ns.

At sweep speeds of 100 ms/div and slower, the time to acquire the 2048 sample points for acquisition memory is greater than 1 second. At these sweep speeds the screen will display "Scope waiting for prestore" when acquiring the 2048 sample points prior to the trigger point or "Scope waiting for poststore" when acquiring the 2048 sample points after the trigger point. These advisories let you know the oscilloscope is still actively acquiring data.

The default value for the s/Div field is 10  $\mu$ s.

### **Zoom (Acquisition Stopped)**

If acquisitions have been stopped, the oscilloscope uses the 2048 sample points stored in acquisition memory to display the new data on screen when the sweep speed is changed. This function would normally be used to zoom in or zoom out on a waveform acquired in Single (single-shot) mode. Zooming either expands or compresses the waveform horizontally and is changed by adjusting the s/Div field.

### **Zoom Example**

Select the s/Div field and turn the knob to set the sweep speed to 200  $\mu$ s/Div, then touch the **Stop Key** to stop acquisitions. Now turn the knob to change the sweep speed and notice how the acquired waveform expands and compresses.

Normally 500 points of the 2k waveform record is displayed on screen. Change the sweep speed to 500 us/div. Now all 2k of the waveform record is compressed and displayed on screen. See figure 23-16.

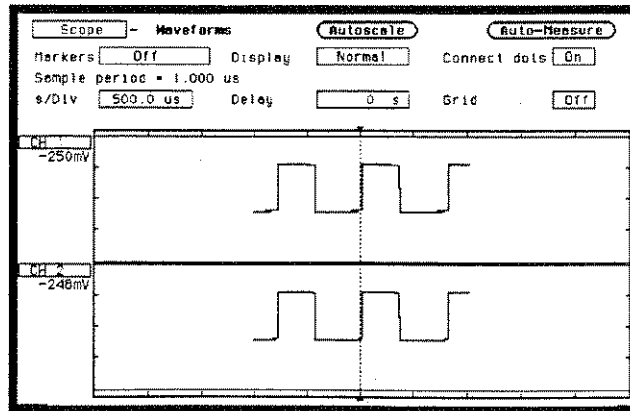

**Figure 23-16. Compressed Waveform**

Now change the sweep speed to 2 us/Div. At 200 us/Div, 500 points were displayed; at 2 us/Div, only 20 points are displayed. When the waveform is expanded, the oscilloscope uses a reconstruction filter to fill in the waveform points to provide a more useable display. When used in conjunction with scrolling (see "Delay Field" paragraph), zooming is very useful in displaying single-shot waveforms.

## **Delay Field**

Delay time is the time offset before or after the trigger point on the waveform and is always measured from the trigger point to the center of the screen. The dotted line at the center of the display is the trigger point. When delay time is zero, the trigger point is at the center of the screen.

When the Delay field is selected, a pop-up will appear and the delay time can be changed by turning the knob. Remember that the trigger point is always delay time zero and is marked by the dotted line. When the trigger point moves to the right side of the screen, the delay time is negative. This means that what you are viewing at center screen is before the trigger point and is referred to as negative time.

When the trigger point is moved to the left side of the screen, the delay time is positive and what you are viewing at center screen is after the trigger point.

Delay time resolution is equal to 2% of the sweep speed setting when using the knob. When using the pop-up keypad, resolution is 100 ps at sweep speeds of 99.9 ns/Div and faster, and can be set to 4-digit resolution at sweep speeds of 100 ns/div and slower.

## **Scrolling (Acquisition Stopped)**

If acquisitions have been stopped, the Delay field controls the portion of the acquisition memory displayed on screen.

When acquisition has been stopped:

Pre-trigger delay range = delay time setting - (1024 X sample rate)  
Post-trigger delay range = delay time setting + (1024 X sample rate)

This means that one-half of data stored in acquisition memory is before the delay time setting and one-half of the data in memory is after the delay time setting.

This function would normally be used to scroll through a waveform acquired in Single (single-shot) mode. Scrolling allows you to view the entire waveform record by adjusting the Delay field.

### Scroll Example

Select the s/Div field and turn the knob to set the sweep speed to 200 us/div, then touch the Stop key to stop acquisitions. Select the Delay field and turn the knob to change delay time to approximately -1 ms. As shown in figure 23-17, you are now looking at the beginning of the waveform record. You can now scroll through the entire 2k waveform record, both before and after the trigger point. When used in conjunction with zooming (see "s/Div Field" paragraph), scrolling is very useful in displaying single-shot waveforms.

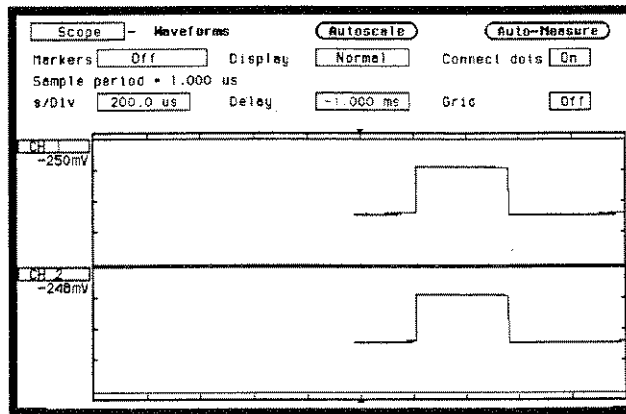

Figure 23-17. Scroll Beginning of Waveform



## Autoscale Field

The Autoscale field is located in the middle of the top row of fields in all scope main menus except when the Markers field is set to Statistics. When the Autoscale field is selected, a pop-up appears allowing you to cancel or continue the autoscale. See figure 23-18.

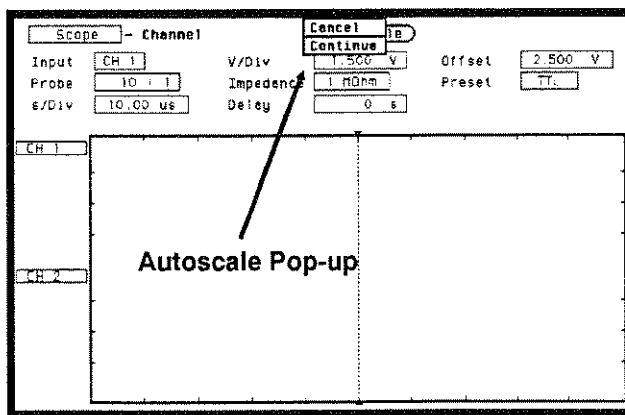

Figure 23-18. Autoscale Pop-up

If you have inadvertently selected autoscale or wish to abort the autoscale, select Cancel. If the Continue field is touched, the autoscale function is started and the advisory Autoscale is in progress is displayed. The oscilloscope automatically sets V/Div (vertical sensitivity), channel Offset, s/Div (sweep speed), and trigger Level so that the input signals are displayed on screen. The oscilloscope checks all vertical inputs and looks for the trigger on channel 1. The following fields are changed when autoscale is complete:

### Channel menu

V/Div	scaled
Offset	scaled

### Trigger Menu

Mode	Edge
Source	set to lowest number input with signal present
Level	scaled
Slope	positive

### Any menu

s/Div  
Delay

### When a Signal is Found

If a signal is found on any of the vertical inputs, the oscilloscope determines the frequency of the signals and automatically scales the vertical sensitivity, offset, sweep speed, and trigger level to display the waveform on screen. The oscilloscope will normally display between 1 and 3 complete cycles of the waveform.

If a signal is present at more than one input, the trigger source is always assigned to the signal input on channel 1. This input is also used to scale the sweep speed. If only one vertical input has a signal present, that signal is the trigger source.

### If No Signal is Found

If no signal is found on any of the vertical inputs, the oscilloscope displays the advisory **No signal found**, then displays **Auto Triggered**, and the oscilloscope is placed in an auto-trigger mode. The auto-trigger mode allows the oscilloscope to auto-sweep and display a baseline anytime a trigger signal is not present.

## Trigger Menu

### Introduction

The Trigger menu controls the selection of trigger modes for the oscilloscope. The Trigger menu has two modes:

- Edge
- Immediate

The default Trigger menu is shown in figure 24-1.

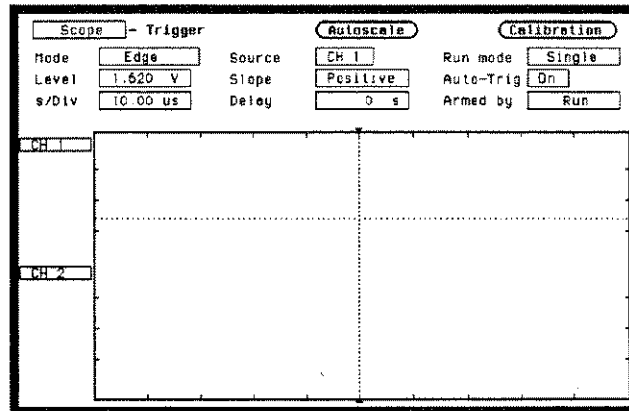

Figure 24-1. Trigger Specification Menu

### Calibration

When the Calibration field is selected, a pop-up will appear showing the calibration menu. Information on when and how to calibrate the oscilloscope is found in Appendix D.

## Trigger Point Marker

The trigger point marker, is the dotted vertical line at the center of the waveform display. This dotted vertical line, points to the place on the waveform where the trigger source waveform or trigger condition intersects. This point of intersection is where timebase delay is referenced. This point represents a delay time of zero seconds. See figure 24-2.

If delay time is set to greater than 5 times the sweep speed, the trigger marker will be moved off screen.

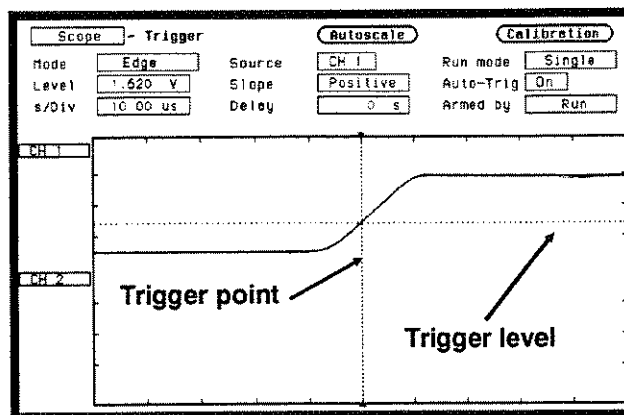

Figure 24-2. Trigger Point

## Mode Field

The Mode field is located on the left side of the top row of fields and selects the trigger mode for the oscilloscope. When you select the Mode field, it will toggle between **Edge** and **Immediate**.

The default selection for the Mode field is Edge.

## Immediate Trigger Mode

Immediate trigger mode causes the oscilloscope to trigger by itself after the arming requirements are met. This can be used when a logic analyzer arms the scope or another instrument arms the scope via the BNC connector. The default Immediate trigger menu is shown in figure 24-3.

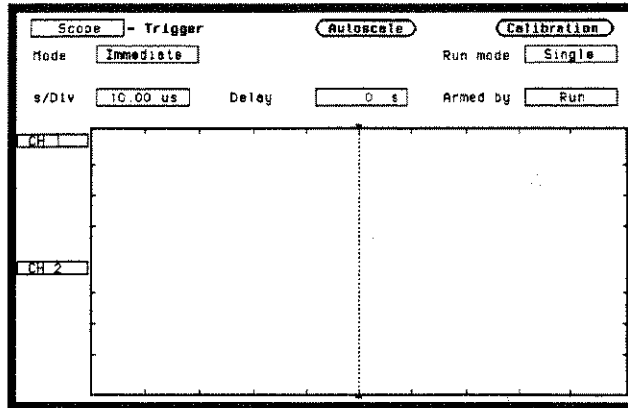

Figure 24-3. Immediate Trigger Mode Default Menu

#### Armed by Field

The Armed by field is located on the right side of the bottom row of fields. When selected, a pop-up will appear that is used to set any arming requirements. See figure 24-4.

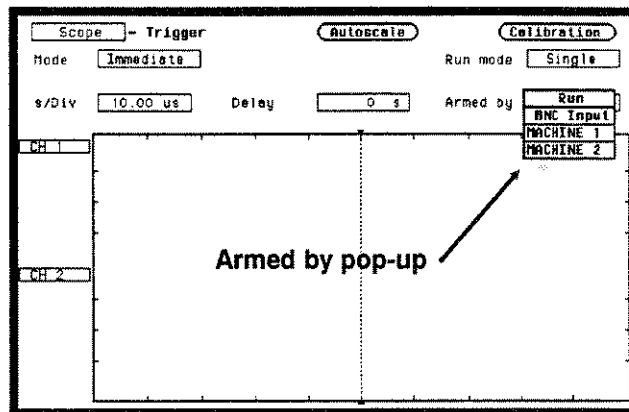

Figure 24-4. Arming Selection Pop-up

**Run.** If Run is selected in the Armed by field, the oscilloscope will be in the free-run mode and the waveform display will not be synchronized to a trigger point.

**BNC Input.** If BNC Input is selected, and the oscilloscope is in the trigger Immediate mode, it triggers and synchronizes itself as soon as it is armed by a signal from the External Trigger Input on the rear panel.

**Machine 1 and 2.** If Machine 1 or Machine 2 is selected, and the oscilloscope is in the trigger Immediate mode, it triggers and synchronizes itself as soon as it is armed by an internal signal from the appropriate analyzer.

The default selection for the Armed by field is Run.

## **Edge Trigger Mode**

Edge trigger is the type of triggering found in all oscilloscopes. In edge trigger mode the oscilloscope triggers at a specified voltage level on a rising or falling edge of one of the input channels.

In this mode you can specify which input is the trigger source, set a trigger level voltage, and specify which edge to trigger on.

### **Source Field**

The trigger Source field is located in the middle of the top row of fields and when selected, will toggle between channels 1 and 2.

The default selection for the Source field is channel 1.

### Level Field

The trigger voltage Level field is located on the left side of the middle row of fields and is used to set the voltage level at which the trigger source waveform crosses the trigger marker. When the Level field is selected, a pop-up will appear which allows the trigger level to be changed by turning the knob. See the upper pop-up in figure 24-5.

When the trigger level is changed, the waveform moves on the display to maintain the trigger point (where waveform edge crosses the trigger level line). If the trigger level is set above or below the waveform, trigger is lost and the waveform display will be unsynchronized.

The trigger level, when set with the knob, can be any voltage value contained within the waveform display window in increments of 1% of full scale vertical voltage range (V/Div X 4). For example, if full scale voltage range were 500 mV, trigger level could be set in increments of 20 mV.

Trigger level can also be entered from the keypad. A Numeric Entry pop-up will appear when the first key is touched. See the lower pop-up in figure 24-5.

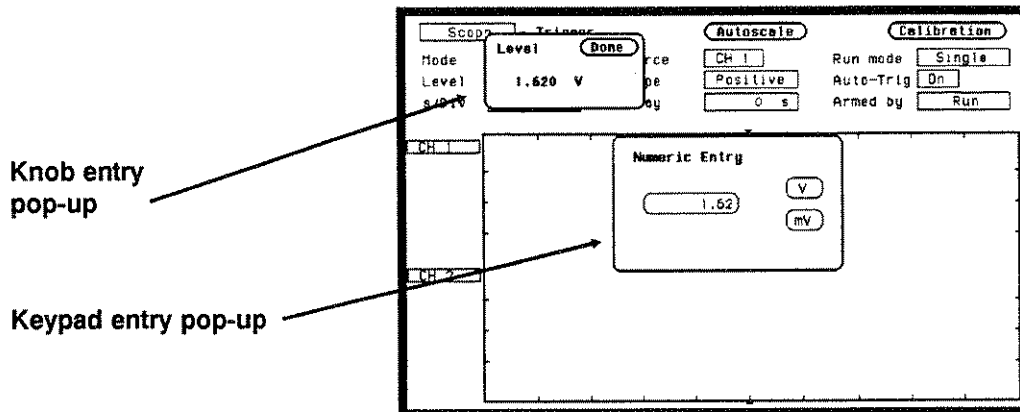

Figure 24-5. Trigger Level Entry Pop-ups

Since the trigger level range is limited by the voltage values set for the waveform window, the voltage level range can be easily determined. Turn the knob in both directions until the Level field reads minimum and maximum voltage. These voltage values are the trigger level limits of the waveform window.

The default value for the Level field is 1.62 V (TTL preset value).

### **Slope Field**

The Slope field is located in the middle of the middle row of fields. It selects which edge of the trigger source waveform the oscilloscope will trigger on. When Slope is selected, it will toggle between positive and negative.

The default selection for the Slope field is Positive.

### **Auto-Trig Field**

The Auto-Trig field is located on the right side in the middle row of fields. It lets you specify whether or not the acquisitions should wait for the specified trigger condition to occur. When the Auto-Trig field is touched, the field will toggle between On and Off.

**On.** When auto-trigger is set to on, the oscilloscope waits for approximately 1 sec. for a trigger to occur. If a trigger does not occur within that time, whatever is in the acquisition memory is displayed and "Auto triggered" is displayed:

- if no signal is on the input, the oscilloscope will display a baseline.
- if there is a signal but the specified trigger condition has not been met within 1 sec, the waveform display will not be synchronized to a trigger point.

**Off.** When auto-trigger is set to off, the oscilloscope waits until a trigger is received before the waveform display is updated. If a trigger does not occur, the screen is not updated and "Waiting for Trigger" is displayed.

The default selection for the Auto-Trig field is On.



### Run mode Field

The Run mode field is located on the right side of the top row of fields and is displayed only when in the Trigger menu. This field controls whether the oscilloscope performs a single acquisition or multiple acquisitions. Single mode acquires a waveform on a single acquisition and then stops running. Repetitive mode acquires a waveform a multiple number of times and rebuilds the display after each acquisition. Repetitive mode keeps running until the STOP key is pressed. When powered on, the oscilloscope defaults to the Single mode. There is no pop-up for this field. When selected, it simply toggles between Single and Repetitive.

**Single Mode Run.** After the Run mode field is set to Single, you start the oscilloscope running in the single-acquisition mode by pressing the RUN key on the front panel. In this mode, the oscilloscope makes a single acquisition, displays the results, then waits until the RUN key is touched again before making another acquisition.

**Repetitive Mode Run.** After the Run mode field is set to Repetitive, you start the oscilloscope running in the Repetitive (repetitive single-shot) mode by pressing the RUN key on the front panel. In this mode, the display is rebuilt each time a new acquisition is made. When you want to stop making repetitive acquisitions, touch the STOP key on the front panel. To resume making repetitive acquisitions, touch the RUN key again.



---

Before a repetitive run can be executed, all analyzers must either be turned off, or they must have acquired data.

---



## Waveforms Menu

### Introduction

The Waveforms menu controls how the oscilloscope displays the waveforms. The waveforms may be displayed in normal, averaged, or accumulated mode. This menu also controls the connect-the-dots display feature. The default Display menu is shown in figure 25-1.

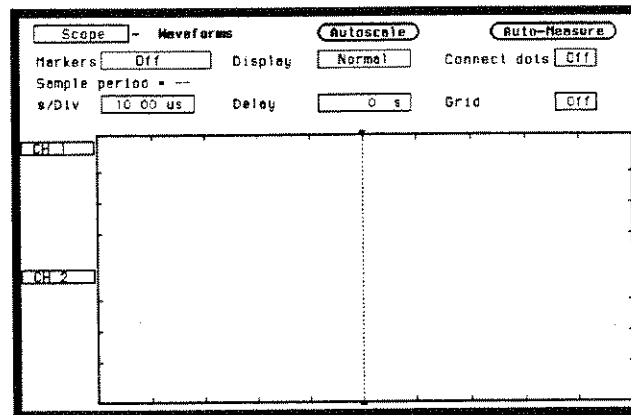

Figure 25-1. Waveforms Display Menu

### Scope Field

The Scope field located in the upper left corner of the menu is used for accessing the System Configuration menu, any assigned analyzers, and the mixed mode display operation. More information on mixed mode displays and the system configuration menu is found in the appropriate chapters.

### Auto-Measure Field

Automatic parametric measurements are functions built into the digitizing oscilloscope that make parametric measurements on a displayed waveform.

The Auto-measure field is located in the upper right corner of the Waveforms menu. When the Auto-measure field is selected, a pop-up will appear that lists the parameters measured for the channel selected. See Figure 25-2.

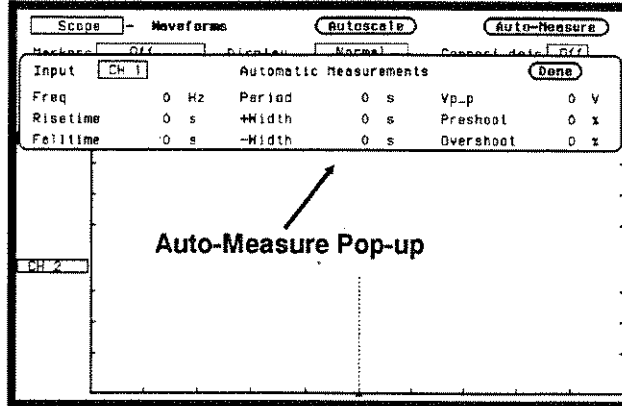

**Figure 25-2. Automatic Measurement Pop-up**

The channel field, which is located in the upper right corner of the pop-up, will toggle between channel 1 and channel 2 when selected. The default selection for this field is channel 1.

There are nine automatic measurements made from the data that is displayed in the waveform display:

- Period
- Risetime
- Falltime
- Frequency
- + Width
- Width
- Vp\_p
- Preshoot
- Overshoot

Keep the following in mind when making measurements.

- At least one full cycle of the waveform with at least two like edges must be displayed for Period and Freq measurements.

- A complete positive pulse must be displayed to make a + Width measurement, and a complete negative pulse must be displayed to make a -Width measurement.
- Risetime, Falltime, Preshoot, and Overshoot measurements will be more accurate if you expand the edge of the waveform by selecting a faster sweep speed.

## Top and Base Voltages

All measurements except Vp-p are calculated using the Vtop (100% voltage) and Vbase (0% voltage) levels of the displayed waveform. The Vtop and Vbase levels are determined from an occurrence density histogram of the data points displayed on screen.

The digitizing oscilloscope displays 6-bit vertical voltage resolution. This means the vertical display is divided up into  $2^6$  voltage levels. Each of these 64 levels is called a quantization level. Each waveform has a minimum of 500 data points displayed horizontally on screen. Each of these data point sets have one quantization level assigned to it. The histogram is calculated by adding the number of occurrences of each quantization level of the displayed data point sets on the displayed waveform.

The quantization level with the greatest number of occurrences in the top half of the waveform corresponds to the Vtop level. The quantization level with the greatest number of occurrences in the bottom half of the waveform corresponds to the Vbase level.

If Vtop and Vbase do not contain at least 5% of the minimum (500) data points displayed on screen, Vtop defaults to the maximum voltage (Vmaximum) and Vbase defaults to the minimum voltage (Vminimum) found on the display. An example of this case would be measurements made on sine or triangle waves.

From this information the instrument can determine the 10, 50, and 90% points, which are used in most automatic measurements. The Vtop or Vbase of the waveform is not necessarily the maximum or minimum voltage present on the waveform. If a pulse has a slight amount of overshoot, it would be wrong to select the highest peak of the waveform as the top since the waveform normally rests below the perturbation.

## Automatic Measurement Example

To demonstrate how to make automatic measurements, set up the oscilloscope as described below. This setup will be used throughout the remainder of this section.

### Connecting the Equipment

Connect a BNC tee adapter and BNC cables to the oscilloscope as shown in figure 25-3.

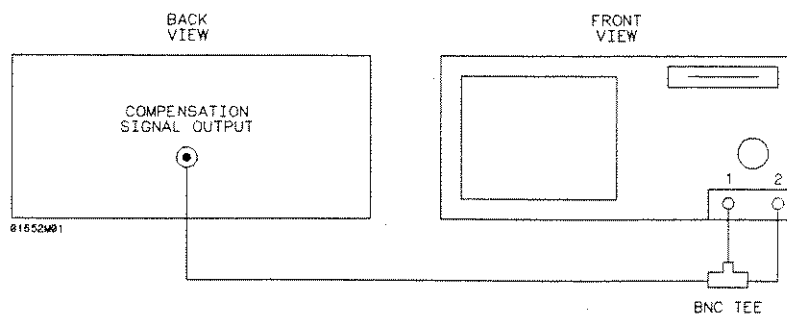

Figure 25-3. Equipment Setup

### Setting Up the Oscilloscope

1. Turn the instrument on.
2. From the System Configuration menu, turn the oscilloscope on and all analyzers off.
3. Touch CHAN key and from the default Channel Specification menu, make the following changes:

Input CH 1 Probe field to 1:1

Input CH 1 Impedance field to 50 Ohms

Input CH 2 Probe field to 1:1

Input CH 2 Impedance field to 50 Ohms

4. Select **Autoscale**, then select **Continue**.

5. Touch the TRIG key and set the Run mode to Repetitive.
6. Select the Waveforms menu and toggle Connect dots field to on. The displayed waveform should now look like figure 25-4.

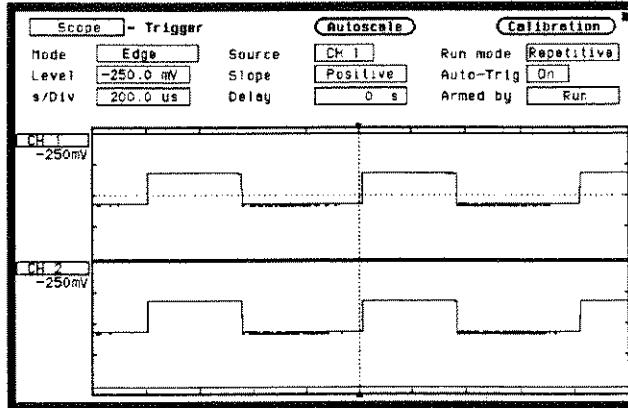

Figure 25-4. Autoscaled Waveform

### Rise Time Measurement

Risetime is measured on the positive-going edge of the waveform and is the time it takes the waveform to transition between the 10% voltage point and the 90% voltage point.

1. Select the s/Div field and change the sweep speed to 5 ns/div. The expanded waveform should look like the figure below.

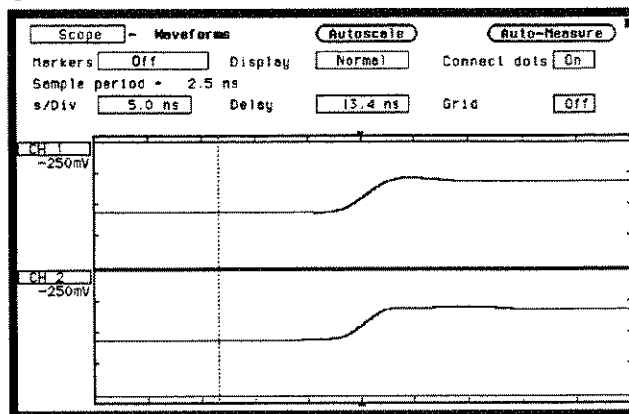

Figure 25-5. Expanded Waveform

Expanding the edge on the waveform will give more accurate results because more data points on the rising edge will be displayed.

2. From the Waveforms menu select the **Auto-Measure** field. The Risetime value is displayed in the Automatic Measurements listing pop-up.

Notice that Period, Faltime, Freq, + Width, and -Width listings are blank. Because only the rising edge of the waveform is displayed, there is insufficient data at this time to make these measurements.

3. Select **Done**. You are now back to the Waveform menu.

## Fall Time Measurement

Fall time is measured on the negative-going edge of the waveform and is the time it takes the waveform to transition between the 90% voltage point and 10% voltage point. You are currently displaying the positive-going edge of the waveform, so you need to change it to the negative-going edge.

4. Touch the TRIG key and toggle the **Slope** field in the Trigger Specification menu to **Negative**. Notice the negative-going edge of the waveform is now displayed as shown in figure 25-6.
5. Touch the Display key and select the **Auto-Measure** field in the Waveforms menu. The Faltime value is now displayed in the Automatic Measurement listing pop-up.

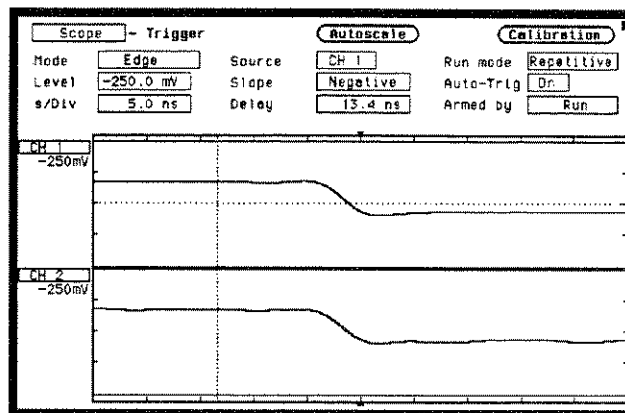

Figure 25-6. Negative Edge Of Waveform



6. Now measure the falltime on CH 2. Select the **Input** field in the Automatic Measurement listing pop-up and toggle to CH 2.
7. All readings in the Automatic Measurement listing pop-up are now for CH2. Falltime is now being measured on CH 2.

### **Vp-p Measurement**

The peak-to-peak voltage measurement uses the maximum voltage and the minimum voltage values found in the data displayed on screen.

$$\text{Vp-p} = \text{Vmaximum} - \text{Vminimum}$$

8. Notice the Vp\_p measurement displayed in the Automatic Measurements listing pop-up. This reading is for the channel currently selected.
9. Select **Done** to exit the Automatic Measurements listing pop-up.

## Period and Frequency Measurements

Period and Freq (frequency) measurements are made using the first two like edges of an input displayed on screen. At least one full cycle of the waveform must be displayed to make the measurements. If a full cycle is not present, the Period and Freq measurements in the auto-measure field will be blank. Period and Freq are measured using the time (t) at the 50% level of the edges.

If the first edge on the display is rising then:

$$\text{Period} = t_{\text{rising edge 2}} - t_{\text{rising edge 1}}$$
$$\text{Freq} = 1/(t_{\text{rising edge 2}} - t_{\text{rising edge 1}})$$

If the first edge on the display is falling then:

$$\text{Period} = t_{\text{falling edge 2}} - t_{\text{falling edge 1}}$$
$$\text{Freq} = 1/(t_{\text{falling edge 2}} - t_{\text{falling edge 1}})$$

Re-scale the waveform to display at least one full cycle of the waveform, then make a Period and Freq measurement on CH 1.

1. From the Waveform menu, select s/Div and change s/Div field to 100  $\mu$ s to display only one full cycle of the waveform. See figure 25-7.
2. Select **Auto-Measure** and notice the Period and Freq measurements displayed in the Automatic Measurement listing pop-up.

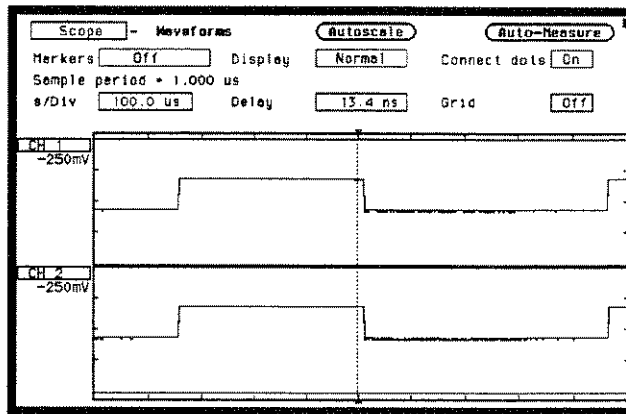

Figure 25-7. One Full Cycle Waveform

## **+ Width and -Width Measurements**

+ Width (positive pulse width) and -Width (negative pulse width) measurements are made using the time (t) at the 50% level of the waveform edges. At least one positive-going edge followed by a negative-going edge of the waveform must be present to make a + Width measurement and at least one negative-going edge followed by a positive-going edge must be present to make a -Width measurement. If these conditions are not present, the + Width and/or -Width measurements in the auto-measure field will be blank.

If the first edge on the display is rising then:

$$\begin{aligned} + \text{Width} &= t_{\text{falling edge 1}} - t_{\text{rising edge 1}} \\ - \text{Width} &= t_{\text{rising edge 2}} - t_{\text{falling edge 1}} \end{aligned}$$

If the first edge on the display is falling then:

$$\begin{aligned} + \text{Width} &= t_{\text{falling edge 2}} - t_{\text{rising edge 1}} \\ - \text{Width} &= t_{\text{rising edge 1}} - t_{\text{falling edge 1}} \end{aligned}$$

3. Be sure the displayed waveform is at least one full cycle. If not, touch TRIG key, then select s/Div. Change s/Div field to 100  $\mu$ s to display only one full cycle of the waveform. See figure 25-7.
- 4 Touch Display key, then select **Auto-Measure**. The Period and Freq measurements displayed in the Auto-measure listing pop-up is for the channel selected.

## **Preshoot and Overshoot Measurements**

Preshoot and Overshoot measure the perturbation on a waveform above or below the top and base voltages (see "Top and Base Voltages" section earlier in this chapter). These measurements use all data displayed on screen, therefore it is very important that only the data of interest be displayed. If you want to measure preshoot and overshoot on one edge of a waveform, then only display that edge. If you want to measure the maximum preshoot and overshoot on a waveform, then display several cycles of the waveform.

Preshoot is a perturbation before a rising or a falling edge and is measured as a percentage of the top-base voltage. Overshoot is a perturbation after a rising or a falling edge and is measured as a percentage of the top-base voltage

If the measured edge is rising then:

$$\text{Preshoot} = \left[ \frac{V_{\text{base}} - V_{\text{minimum}}}{V_{\text{top-base}}} \right] \times 100$$

$$\text{Overshoot} = \left[ \frac{V_{\text{maximum}} - V_{\text{top}}}{V_{\text{top-base}}} \right] \times 100$$

If the measured edge is falling then:

$$\text{Preshoot} = \left[ \frac{V_{\text{maximum}} - V_{\text{top}}}{V_{\text{top-base}}} \right] \times 100$$

$$\text{Overshoot} = \left[ \frac{V_{\text{base}} - V_{\text{minimum}}}{V_{\text{top-base}}} \right] \times 100$$

Re-scale the waveform to display a rising edge, then make a Preshoot and Overshoot measurement on CH 1.

1. Select **s/Div** and change s/Div field to 5 ns to display a rising edge on the waveform. See figure 25-8.
2. Select **Auto-Measure**. Notice the Preshoot and Overshoot measurements displayed in the Automatic Measurement listing pop-up.

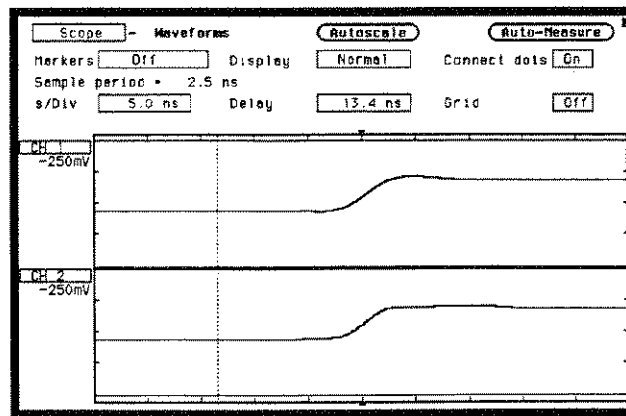

Figure 25-8. Rising Edge on Waveform

---

## Marker Measurements

In addition to automatic parametric measurements, the oscilloscope also has two markers for making time and voltage measurements either manually (Time) or automatically (Search).

To demonstrate how to make marker measurements, connect the oscilloscope as shown in figure 25-3 and reset the oscilloscope as described below.

1. Turn the instrument on.
2. From the System Configuration menu, turn the oscilloscope on and all analyzers off.
3. Touch CHAN key, then from the default Channel Specification menu, make the following changes:

Input CH 1 Probe field to 1:1

Input CH 1 Impedance field to 50 Ohms

Input CH 2 Probe field to 1:1

Input CH 2 Impedance field to 50 Ohms

4. Select **Autoscale**, then select **Continue**.

5. Touch the TRIG key and set the Run mode to Repetitive.
6. Select the Waveforms menu and toggle Connect dots field to on. The displayed waveform should now look like figure 25-9.

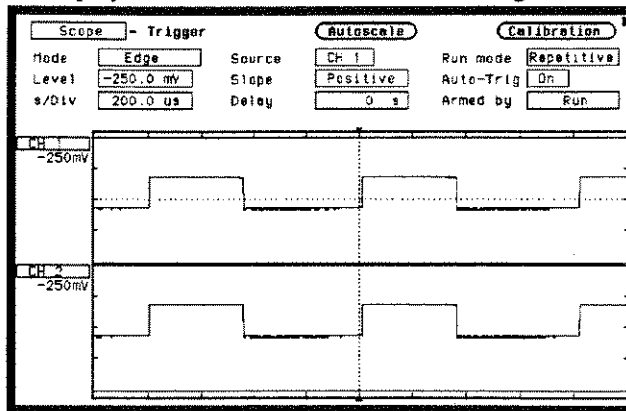

Figure 25-9. Marker Measurement Setup Display

## Markers Field

In the Waveforms menu, the Markers field is located on the left side of the top row of fields, and can only be accessed from the Oscilloscope's Waveforms menu. When the Markers field is selected, a pop-up appears as shown in figure 25-10.

Marker field pop-up

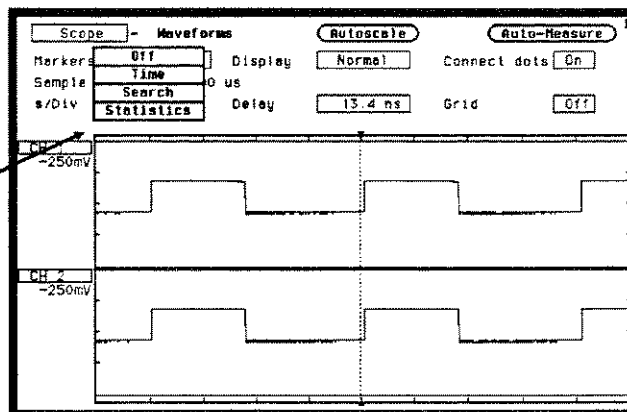

Figure 25-10. Markers Field Pop-up

The default selection for the Markers field is Off.

### Sample Period Display

Any time the Markers field is Off, the sample period of the acquired waveform is displayed directly below the markers field. A sample period is the time period between acquired sample points and is the inverse of sample rate (digitizing rate). Sample period is a function of sweep speed and can only be changed by changing the s/Div field.

### Time

When the Time field is selected from the Markers pop-up, the Sample period = \_\_ disappears and a new middle row of fields appear in the Waveforms menu. See figure 25-11.

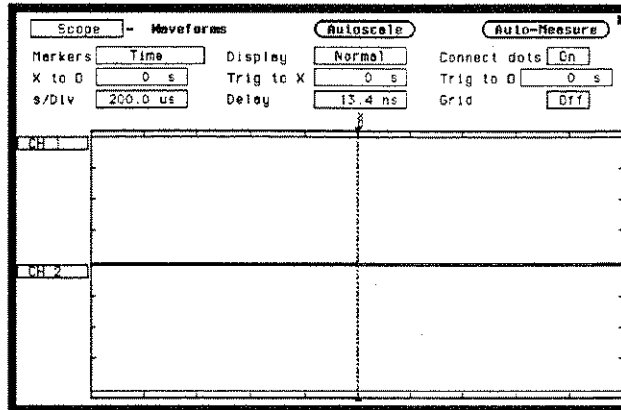

Figure 25-11. Time Markers Field Pop-up

### X to O Field

The X to O field is located on the left side of the middle row of fields and displays the time (delta time) between the X marker and the O marker. When the X to O field is selected, turning the knob will move both the X and the O marker across the display without changing the value in the X to O field. However, the values in the Trig to X and Trig to O fields will change to reflect the movement of the X and O markers.



The value in the X to O field can be changed by changing the Trig to X or Trig to O values, or by changing the X to O value from the pop-up. The knob entry pop-up will appear when you select the X to O field.

When the time value of X to O is changed using the knob, half the difference of the new value and old value is subtracted from the X marker and half is added to the O marker.

### **Trig to X Field**

The Trig to X field is located in the middle of the middle row of fields. The X marker is shown on the waveform display as a dotted line with an X above it. The time displayed in the Trig to X field is measured from the trigger point to the X marker. The trigger point is marked with a dotted line on the waveform display and is always time 0.

When the Trig to X field is selected, the time value can be changed by turning the knob or by entering a time value from the Numeric Entry pop-up. The Numeric Entry pop-up will appear when any key is touched on the keypad.

Resolution for the Trig to X time values is 2% of the sweep speed setting. The default value for the Trig to X field is 0 s.

### **Trig to O Field**

The Trig to O field is located on the right side of the middle row of fields. The O marker is shown on the waveform display as a dotted line with an O above it. The time displayed in the Trig to O field is measured from the trigger point to the O marker.

When the Trig to O field is selected, the time value can be changed by turning the knob or by entering a time value from the Numeric Entry pop-up. The pop-up will appear when any key is touched on the keypad.

Resolution for Trig to O time values is 2% of the sweep speed setting. The default value for the Trig to O field is 0 s.

**Search** When **Search** is selected from the Markers field, a new middle row of fields and the **Specify Search Markers** field will appear. See figure 25-12.

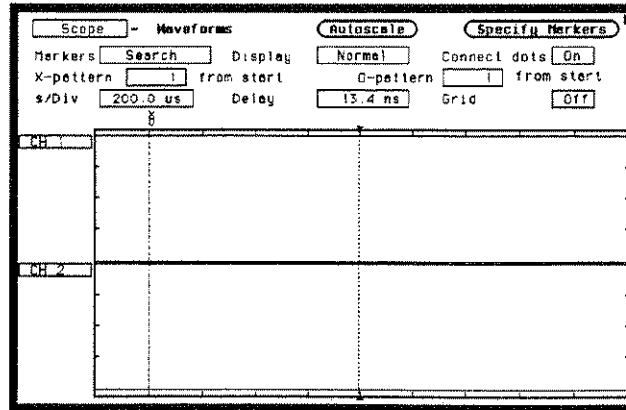

Figure 25-12. Search fields

**Specify Search Markers**

The **Specify Search Markers** field is located in the upper right corner of the Waveforms menu. When selected, a Search Markers pop-up will appear. After Search Markers criteria is set, the X and O markers will be positioned on the waveform, as specified, with voltage values displayed below the waveform label. See figure 25-13.

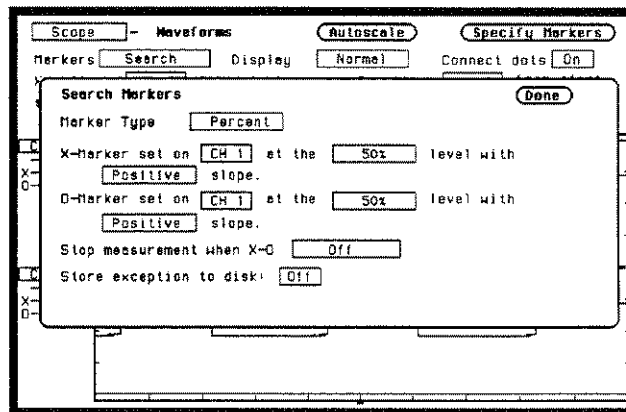

Figure 25-13. Search Markers Pop-up

### Type markers

When the **Type markers** field is selected, it will toggle between Percent and Absolute.

The **Percent** type setting is for levels that are a percentage of the top-to-base voltage value of a waveform. The top-to-base voltage value of a square wave is typically not the same as the peak-to-peak value. The oscilloscope determines the top and base voltages by finding the flattest portions of the top and bottom of the waveform. See figure 25-14. The top and base values do not typically include preshoot or overshoot of the waveform. The peak-to-peak voltage is the difference between the minimum and maximum voltage found on the waveform.

The **Absolute** type allows you to set an exact voltage level to the X or O marker.

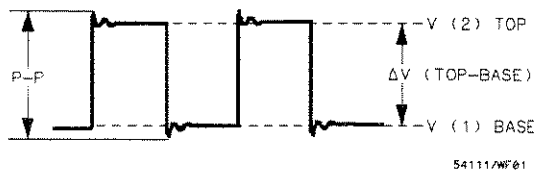

**Figure 25-14. Top And Base Levels**

**X-Marker set on**

**O-Marker set on**

The **X-O Marker set on** field assigns an input waveform (CH1 or CH2) to the X or O marker. When you select this field, the field will toggle between the waveform sources.

The default selection for the **Marker set on** field is CH1.

at the \_\_\_ level

When the type marker is set to Percent, the at the \_\_\_ level field sets the X or O marker to a percentage level (from 10% to 90%) of the top-base voltage. When the type marker is set to Absolute, you can set the marker to an exact voltage level.

The Percentage or Absolute voltage can be changed by turning the knob or by entering a value from the keypad. Percent values from 10% to 90% in increments of 1% can be entered. Absolute voltage values can be entered in increments of 6 mV. The Percent default value for the at the \_\_\_ level field is 50%. The Absolute default value for the at the \_\_\_ level field is 0 V.

with \_\_\_ slope.

The with \_\_\_ slope field sets the X or O marker on either the positive or negative edge of the selected occurrence of a waveform. When the slope field is selected, the slope will toggle between Positive and Negative. The default selection for the Slope field is Positive.

Stop measurement when X-O \_\_\_

This field lets you set up a stop condition for the time interval between the X marker and O marker. When this field is selected, a pop-up will appear as shown in figure 25-15.

The default selection for the Stop measurement when X-O field is Off.

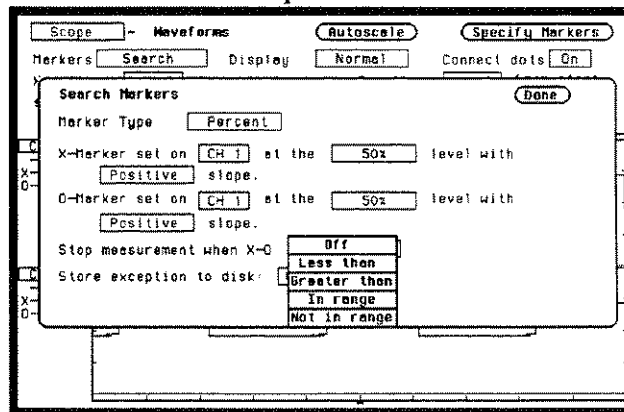

Figure 25-15. Stop Measurement Pop-up

### Less than

When the **Less than** field is selected from the pop-up, a time value field appears to the right of the **Less than** field. See figure 25-16.

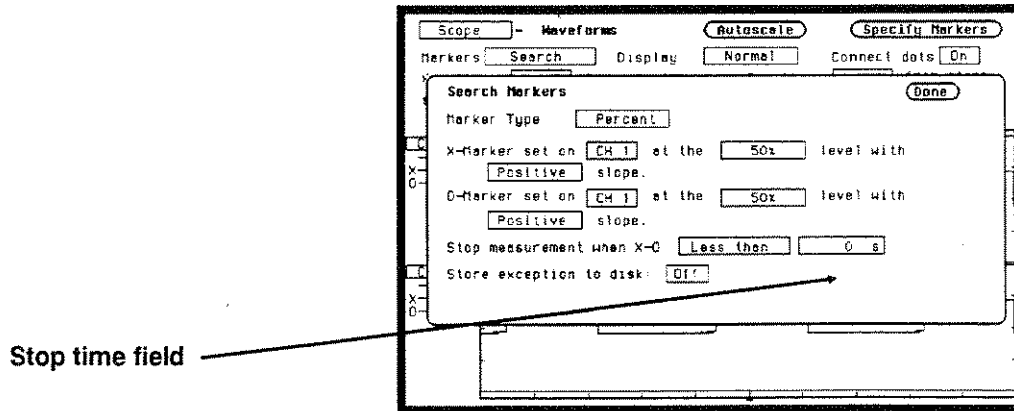
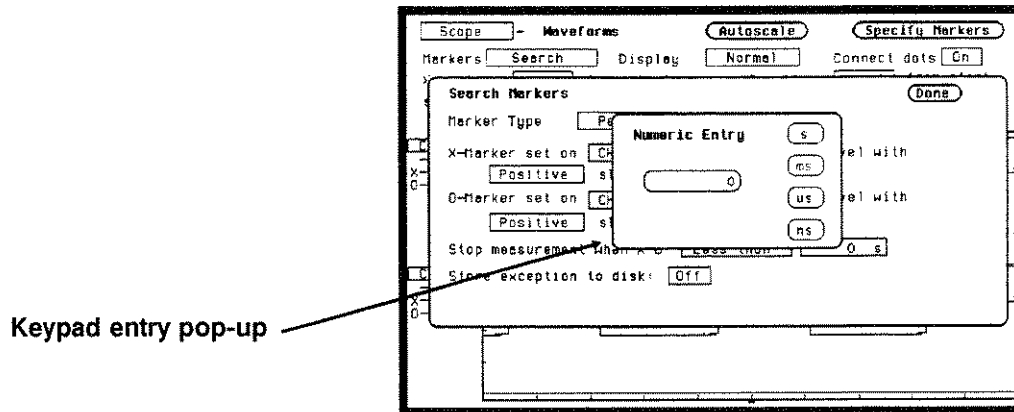

Figure 25-16. Stop Measurement Time Field

When the time value field is selected, the time value can be entered by the keypad. See figure 25-17.



Keypad entry pop-up

Figure 25-17. Stop Measurement Time Numeric Entry

The keypad will appear when you touch any key. The knob is used to set the scale. When using the keypad, resolution is 10 ns at times up to 99.99 ns and can be set to 5-digit resolution for other times up to 100 Megaseconds. Positive times would be used when the X marker is displayed before the O marker, and negative times would be used when the O marker is displayed before the X marker.

When **Less Than** is selected, the oscilloscope will run until the X-O time interval is less than the value entered for the **Less Than** time field. When the condition is met, the oscilloscope will stop acquisitions and display the message "Stop condition satisfied."

### **Greater than**

When the **Greater than** field is selected from the pop-up, a time value field appears to the right of the **Greater Than** field. When the time value field is selected, the time and scale can be entered the same as for the **Less Than** field.

When **Greater Than** is selected, the oscilloscope will run until the X-O time interval is greater than the value entered for the **Greater Than** time field. When the condition is met, the oscilloscope will stop acquisitions and display Stop condition satisfied.

### In range \_\_\_ to \_\_\_

When the **In range \_\_\_ to \_\_\_** field is selected from the pop-up, two time value fields appear next to the In range field. See figure 25-18. The time range for the stop condition is entered using the keypad. When either time value field is selected, the time value can be entered the same as for the **Less Than** field. Default values for **In range \_\_\_ to \_\_\_** is 10 ns.

When **In range \_\_\_ to \_\_\_** is selected, the oscilloscope will run until the X-O time interval is in the range of the time values entered for the **In range \_\_\_ to \_\_\_** time fields. When the condition is met, the oscilloscope will stop acquisitions and display Stop condition satisfied.

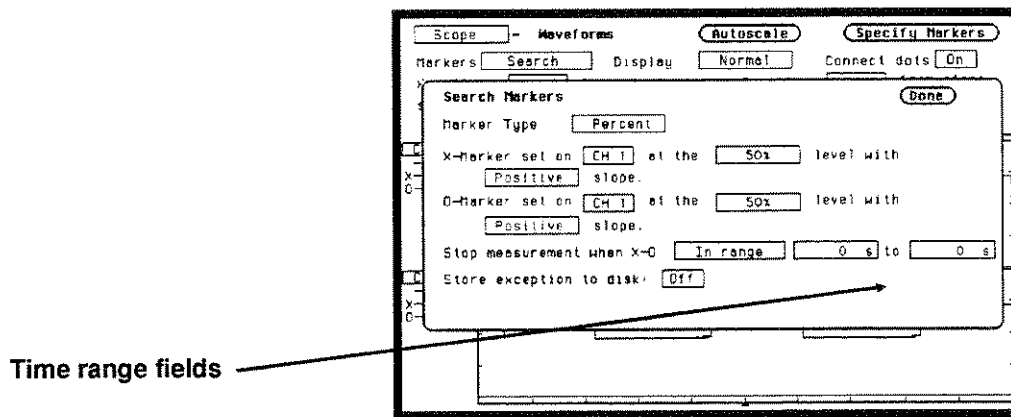

Figure 25-18. Range Fields

### Not in range \_\_\_ to \_\_\_

When the **Not in range \_\_\_ to \_\_\_** field is selected from the pop-up, two time value fields appear next to the Not In Range field. The time range for the stop condition is entered in these time fields. When either time value field is selected, the time can be entered the same as for the **Less Than** field.

When **Not In range \_\_\_ to \_\_\_** is selected, the oscilloscope will run until the X-O time interval is not in the range of the time values entered for the **Not in range \_\_\_ to \_\_\_** time fields. When the condition is met, the oscilloscope will stop acquisitions and display Stop condition satisfied.

Default values for these fields are 10 ns.

### Store exception to disk

When the **Store exception to disk:** field is on, any time the Stop measurement when X-O criterion is met, the measurement is stored to a file on disk. You can designate a **File name** and add a **File description** by selecting those fields and using the Alpha Entry pop-up. After the measurement is stored, the acquisition cycle continues. If the disk is write protected, a notice is displayed and the acquisition cycle is stopped. If the **Stop measurement when X-O** field is off, the Store exception to disk: function is disabled.

**X-pattern \_\_\_ from start**  
**O-pattern \_\_\_ from start**

The X and O **pattern\_\_\_from start** field sets the X or O markers on a specific occurrence of an edge on the waveform. The edge may be the 1st displayed up to the 1024th displayed. The count of edge occurrences is made starting with the first edge displayed on screen, either partial or full.

**Note** 

Auto-marker measurements are made with data that is displayed on screen. Make sure the data of interest is fully displayed on screen. For example, if only part of a positive edge is displayed, the 0% point and 100%-point of the edge is calculated from what is actually displayed on screen. This could cause measurement errors.

When the X or O **pattern\_\_\_from start** field is selected, the occurrence can be changed by turning the knob or by entering a new value from the pop-up keypad. The keypad will appear when you make the first entry on the keypad. Any number from 1 to 1024 in increments of 1 can be entered.

The default value for the **pattern\_\_\_from start Occur** field is 1.



**Statistics** The last field in the Markers pop-up shown in figure 25-10 is **Statistics**. When Statistics is selected from the Markers field, a new middle row of fields appear. See figure 25-19.

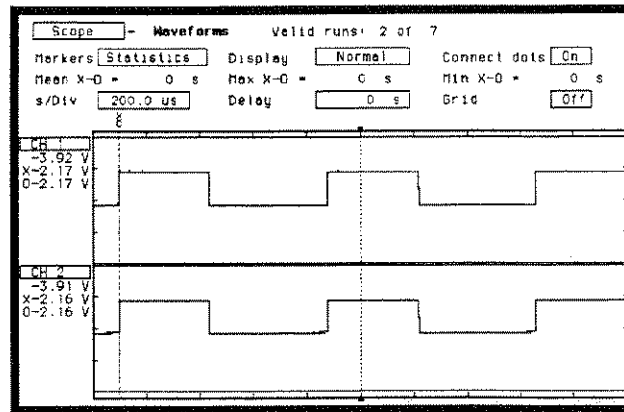

**Figure 25-19. Statistics Fields**

The Statistics field allows you to make minimum, maximum, and mean time interval measurements from marker X to marker O.

Minimum, maximum, and mean (average) X-O marker time interval data is accumulated and displayed until one of the following happens:

1. Autoscale is executed.
2. Auto-marker parameters are changed.
3. Statistics is set to Off.
4. Repetitive Run mode is stopped.

The default for the Min, Max, and Mean fields is 0 s.

## Search Marker Measurement Example

The following example will show how to make an automatic marker measurement using the Search markers. We will set the markers to make an X-O marker measurement on the CH 1 and CH 2 input waveforms. We want to measure the time between the falling edge of the 2nd displayed pulse on CH 1 to the rising edge of the 5th displayed pulse on CH 2. We'll perform the measurement from the 10% point on CH1 to the 90% point on CH 2.

### Connecting the Equipment

Connect the equipment as shown in figure 25-20.



An extra long BNC cable is used on channel 2 so the signal is delayed.

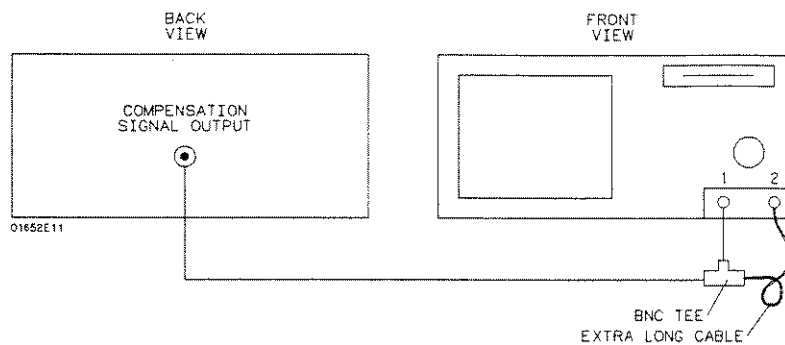

Figure 25-20. Equipment Setup For Search Marker Example

### Making the Measurement

1. In the Waveforms menu, select **Markers** field. When the pop-up appears, select the **Search** field. With Markers set to Search, two new fields will appear: **X-pattern** from start, and **O-pattern** from start. Set the X-pattern to 2, and the O-pattern to 5. Set the s/Div to 500  $\mu$ s. See figure 25-21.

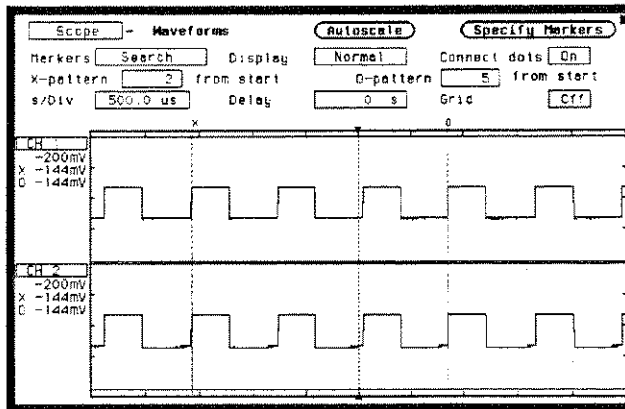

Figure 25-21. Search Markers Menu

2. Select **Specify Search Markers**. Set the Search Markers pop-up as shown in figure 25-22.

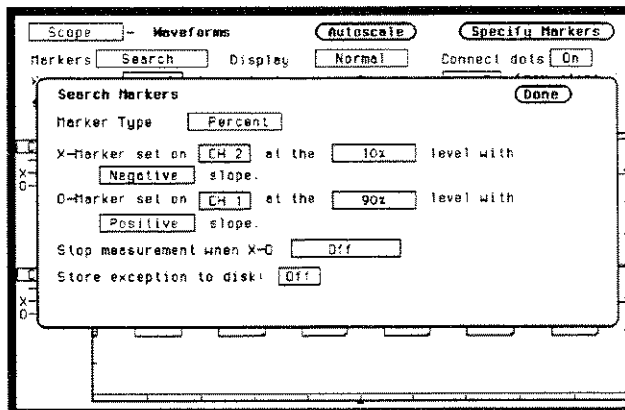
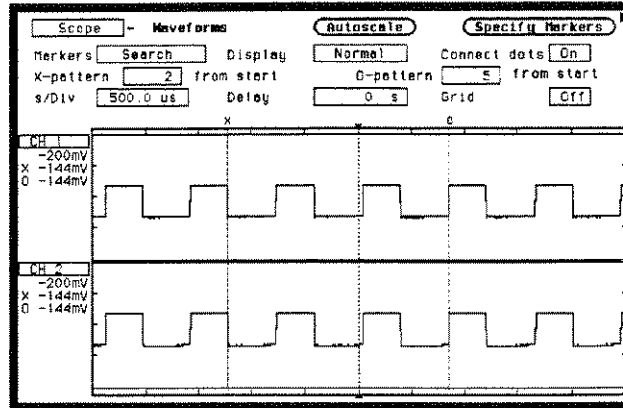

Figure 25-22. Specify Search Markers Pop-up

3. Select the **Done** field to return to the waveform display.

The X marker is on the falling edge of the 2nd displayed pulse and the O marker is on the rising edge of the 5th displayed pulse. See figure 25-23.



**Figure 25-23. Search Marker Measurement Waveform**

4. Select the **Markers** field and switch from Search to Statistics. Notice the statistical minimum, maximum, and mean time interval measurements between the X and the O markers are also displayed. The voltage measurements of where the markers intersect the waveforms are displayed under the CH 1 and CH 2 channel labels.
5. Select the **Delay** field, and turn the knob. Notice that as the waveform is moved across the display, the X and O markers also move to the edges specified in the Search Markers pop-up menu.
6. Set the **Delay** time back to 0 s.

Now let's use the Stop measurement when X-O feature for an X-O measurement.

1. Select the s/Div field and turn the knob to change the sweep speed to 5 ns.
2. Select the Markers field and select Search from the pop-up.
3. Set X-pattern and O-pattern to 1 from start.
4. Select Specify Search Markers and set Pop-up as shown in figure 25-24.

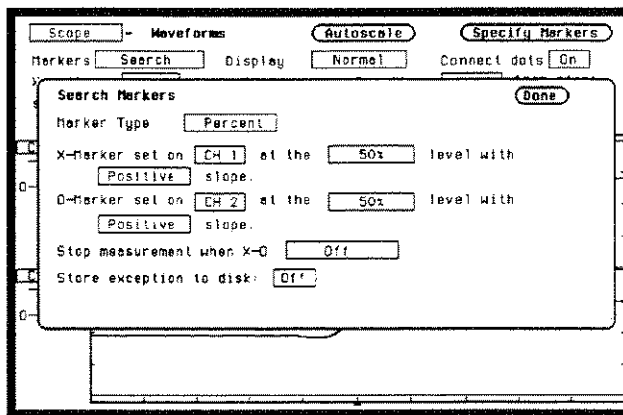

Figure 25-24. Specify Search Markers Pop-up

5. Select Stop measurement when X-O and select Less Than from the pop-up.
6. Select the time field next to the Less Than field. Set the time field to 10 ns.

7. The Specify Search Markers pop-up now looks like figure 25-25.

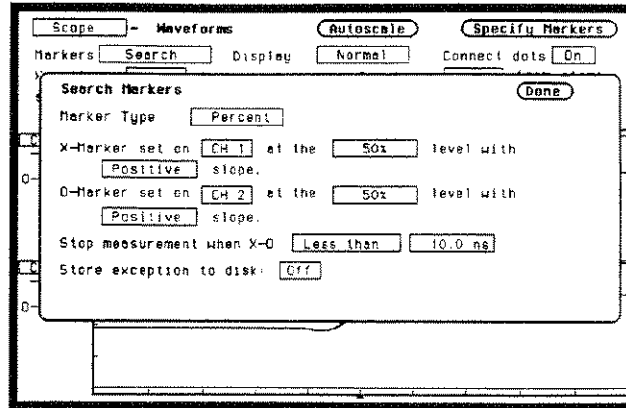

Figure 25-25. Stop Measurement Less than Setup

8. Select the Done field to return to the waveform display. The display now looks like figure 25-26.

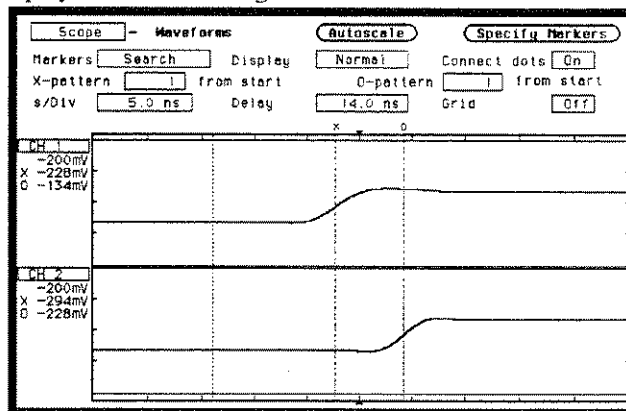

Figure 25-26. Waveform Display

The time interval from X-O in this example is 6.5 ns. Your results may be different because of the different length of BNC cable used to delay channel 2. The oscilloscope was instructed to run until the time interval was less than 5 ns. When the stop condition was satisfied, the oscilloscope stops acquisition and displays the advisory "Stop run criteria met - run stopped."

## Display Field

The **Display** field is located in the middle of the top row of fields. When this field is selected, a pop-up appears as shown in figure 25-27. The selections in this pop-up determine how waveform information is displayed.

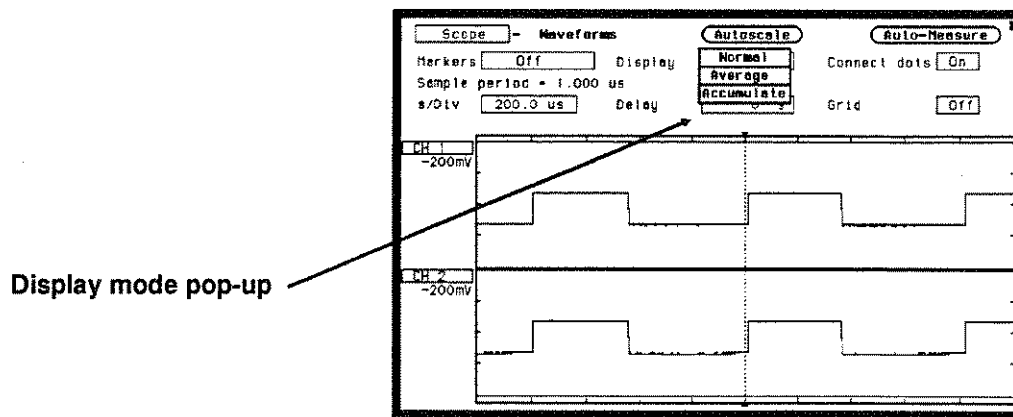

Figure 25-27. Display Field Pop-up

The default selection for the Mode field is Normal.

## Normal Mode

In Normal mode, the oscilloscope acquires waveform data and then displays the waveform. When the oscilloscope makes a new acquisition, the previously acquired waveform is erased from the display and replaced by the newly acquired waveform.

**Average Mode** In Average mode, the oscilloscope averages the data points on the waveforms with previously acquired data. Averaging helps eliminate random noise from your displayed waveforms. When the Average field is selected from the Display mode pop-up, an integer field appears to the right of the AVG# field. When this Average integer field is selected, an integer selection list pop-up appears, listing all possible average selections.

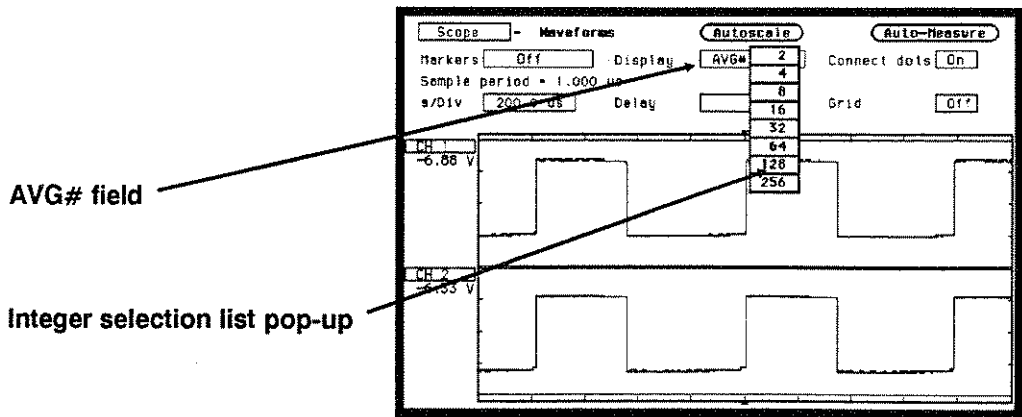

**Figure 25-28. Average Integer Entry Pop-up**

The number of averages can be changed by turning the knob to position the cursor over the integer you want and pressing the SELECT key.

As an example, assume the Average integer field is set to 16. If the Run mode is set to Repetitive, the oscilloscope will immediately start acquiring waveform data and average them together. When the initial 16 waveforms have been acquired, the oscilloscope will momentarily display the advisory "Number of averages have been met". Once the initial 16 waveforms have been acquired, the oscilloscope will only average the last 16 waveforms acquired; all other data will be discarded.

If the Run mode is set to Single, an acquisition is not made until the Run field has been selected. If Average # is set to 16, as in the previous example, the message "Number of averages have been met" would not be displayed until Run has been selected 16 times.



To exit the Average mode, select the **AVG#** field next to the Average Integer field. The default value for the Average # field is 8.

## Accumulate Mode

In Accumulate mode, the oscilloscope accumulates all waveform acquisitions on screen without erasing the previously acquired waveforms. This is similar to infinite persistence on an analog storage oscilloscope. These acquisitions will stay on the display until Mode is changed, or until the waveform is adjusted by a control that causes the display to change, such as s/Div or V/Div.

---

## Connect Dots Field

The **Connect dots** field is located on the right side of the top row of fields. When **Connect dots** field is selected, it will toggle between on and off.

When **Connect dots** is On, each displayed dot will be connected to the adjacent dot by a straight line. A waveform with **Connect Dots** set to On, will be well defined and easier to see.

The default setting for the **Connect dots** field is Off.

---

## Grid

When the **Grid** field is selected, it will toggle between on and off. When the grid is turned on, the major divisions for both time and voltage will be marked with dotted lines.



## Mixed Mode Displays

### Introduction

This chapter explains mixed mode displays for:

- timing/state
- state/state
- timing/scope
- state/timing/scope

The Mixed Mode waveform display will display all of the above mentioned combinations. The main menu and field definitions for each individual type of display is explained in their respective chapters. Only the unique functions and features of the mixed mode displays are given here.

### Mixed Mode field

The Mixed Mode field is located in the same pop-up that is used to access the System Configuration menu, analyzers and the scope. See figure 26-1. The Mixed Mode field will only be available from the Waveform and Listing menus.

Before mixed mode displays can be displayed, the appropriate analyzers and/or scope must be turned on and the appropriate channels or pod bits assigned.

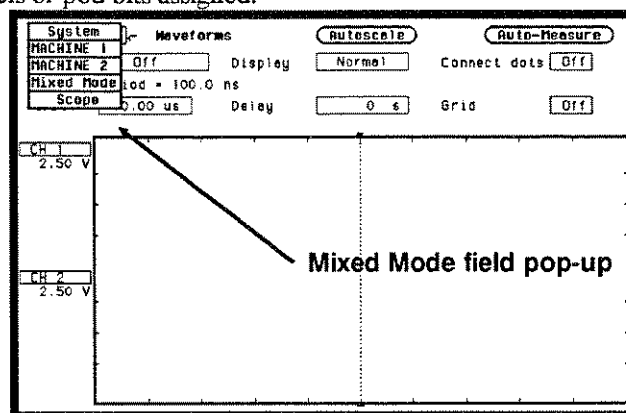

Figure 26-1. Mixed Mode Field

## Timing/State Mixed Mode Display

When both timing and state analyzers are on you can display both the State Listing and the Timing Waveforms simultaneously as shown in figure 26-2.

The data in both parts of the display can be time-correlated as long as Count (State Trace menu) is set to Time.

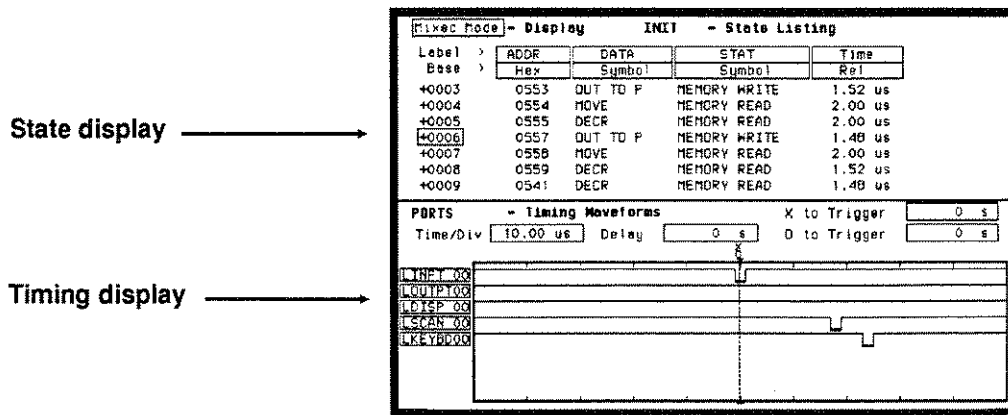

Figure 26-2. Timing/State Mixed Mode Display

The markers for the State Listing and the Timing Waveform in time-correlated Mixed Mode are different from the markers in the individual displays. You will need to place the markers on your points of interest in the time-correlated Mixed Mode even though you have placed them in the individual displays.

## State/State Mixed Mode Display

When two state analyzers are on, the logic analyzer will display both state listings as shown below. Data from state machine 1 is the data with the normal memory location columns filled and with normal black on white video. State machine 2 data is interlaced and displayed in inverse video (white on black). Its memory locations are offset to the right in a column.

Mixed Mode - State Listing						
Label	ADDR	DATA	DATA	STATUS	Time	STAT
Base	Hex	Hex	ASCII	Symbol	Rel	Symbol
+0004					467.4 us	OPCODE FETCH
+0018	0396	ED			680 ns	OPCODE FETCH
+0019	0397	78			920 ns	I/O READ
+0020	6006	E2			7.24 us	OPCODE FETCH
+0021	03C5	ED			680 ns	OPCODE FETCH
+0022	03C6	79			920 ns	I/O WRITE
+0023	6008	62			469.2 us	OPCODE FETCH
+0024	0396	ED			640 ns	OPCODE FETCH
+0025	0397	78			920 ns	I/O READ
+0026	6006	ED			7.28 us	OPCODE FETCH
+0027	03C5	ED			640 ns	OPCODE FETCH
+0028	03C6	79			920 ns	I/O WRITE
+0029	6008	0D			464.4 us	OPCODE FETCH
+0006						
+0030	0396	ED				

Figure 26-3. State/State Mixed Mode Display

To time-correlate data from two state machines, you must set the Count (State Trace menu) for both machines to Time.

The markers for a State/State time-correlated Mixed Mode will be the same as the markers placed in each of the individual State Listings.

## Timing/Scope Mixed Mode Display

When the timing analyzer and the oscilloscope are both on, you can display both the timing waveform and oscilloscope waveform simultaneously as shown below.

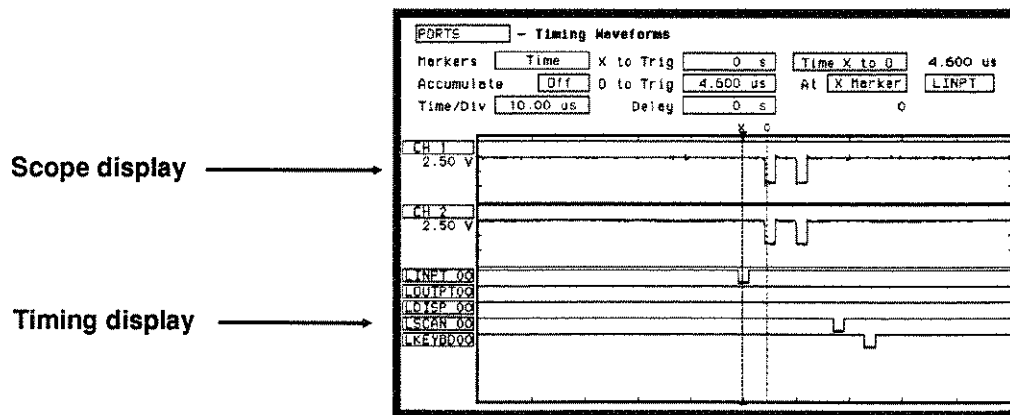

Figure 26-4. Timing/Scope Mixed Mode Display

### Arming the Oscilloscope

Both the state and timing analyzers can arm the oscilloscope. However, to display scope and timing waveforms together in the same display, one (either scope or timing) must arm the other. In addition, after proper arming, the scope and timing waveforms can be time-correlated by setting the scope to trigger Immediately.

From the Trigger Specification menu, select the **Armed by** field. A pop-up will appear with all the arming choices. Select the analyzer machine which you have assign as the timing analyzer in the System Configuration menu. For more information see the chapter "Trigger Menu".

## Displaying Timing Waveforms

After the oscilloscope has been armed by the timing analyzer, the pods can be assigned and accompanying waveforms displayed in the oscilloscope waveform display. To setup mixed mode display in the oscilloscope waveforms display, follow the steps below:

1. From the waveforms display menu, select a channel label. Remember that the inserted waveform will be placed directly below the label you choose.
2. From the waveform selection pop-up shown in figure 26-5, select **Insert waveform** field.

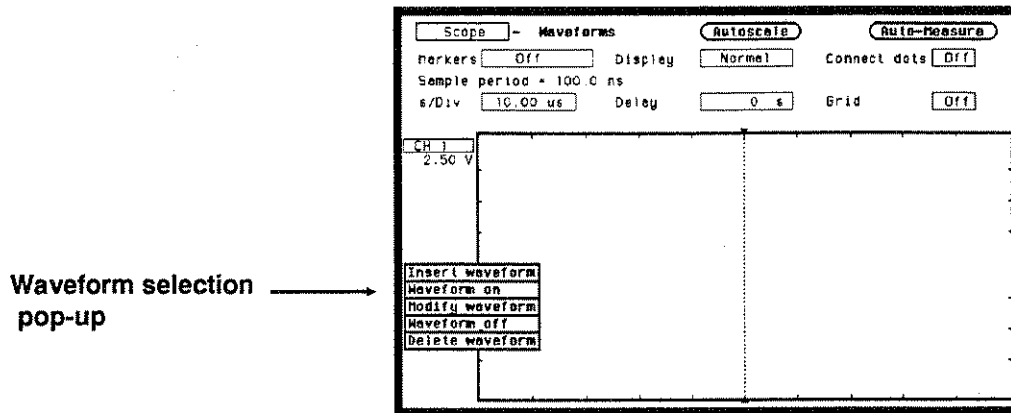

Figure 26-5. Waveform Label Pop-up

3. Since the timing analyzer machine is arming the oscilloscope, another pop-up will appear as shown in figure 26-6 that gives you a choice of Scope or Timing. Select Timing.

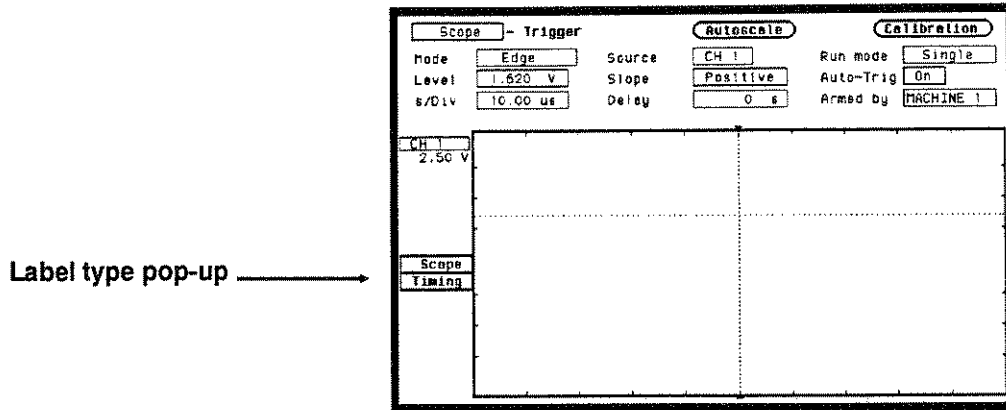

Figure 26-6. Label Type Pop-up

4. A field labeled POD 1 will appear as shown in figure 26-7.

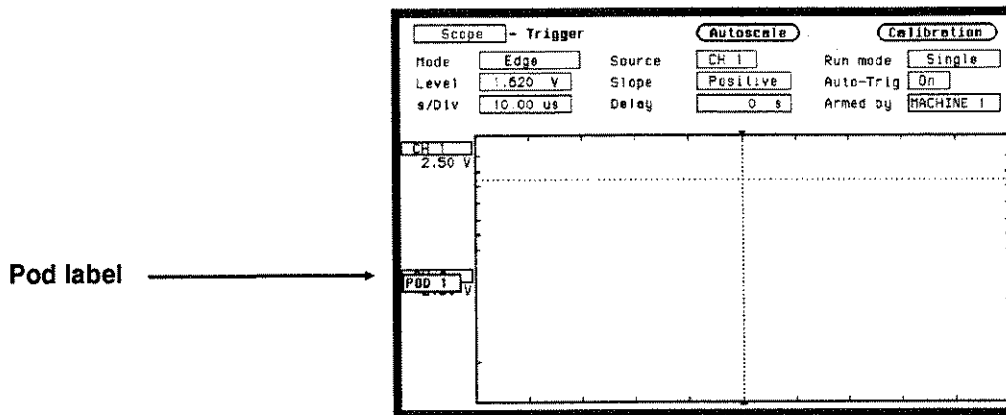

Figure 26-7. Pod Label Field

5. Touch the Select key again and POD 1 will be inserted.
6. Each pod that is inserted, will have the bit number incremented by one, starting from "00". To modify the bit number, select the Bit select field which is just to the right of the Pod number. See the Bit selection field in figure 26-8.



7. When the Bit select pop-up appears, enter the bit number you want by rotating the knob or by using the keypad. The keypad will appear when the first key is touched. See figure 26-8.

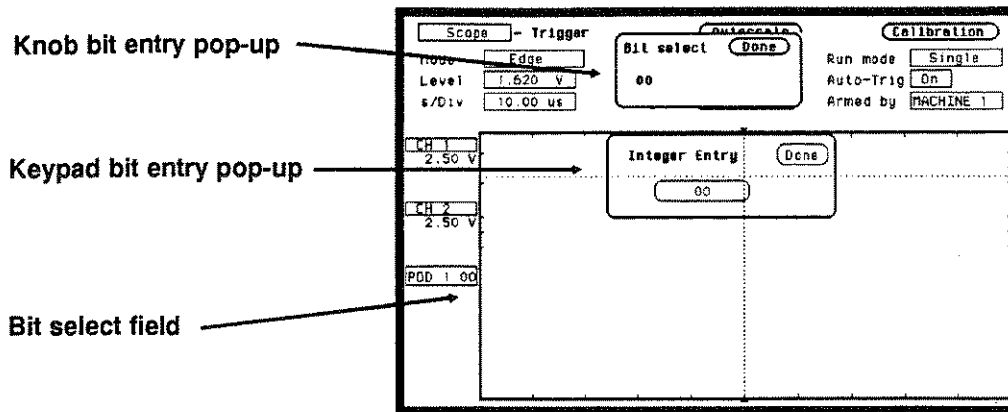

Figure 26-8. Knob And Keypad Entry Pop-ups

The markers for the oscilloscope in time-correlated Mixed Mode are different from the markers in the individual waveforms display. You will need to place the markers on your points of interest in the time-correlated Mixed Mode even though you have placed them in the individual displays.

## State/Timing And Scope Mixed Mode Display

When the state analyzer, timing analyzer and the oscilloscope are all on, you can display both analyzer waveforms and the oscilloscope waveforms simultaneously as shown below.

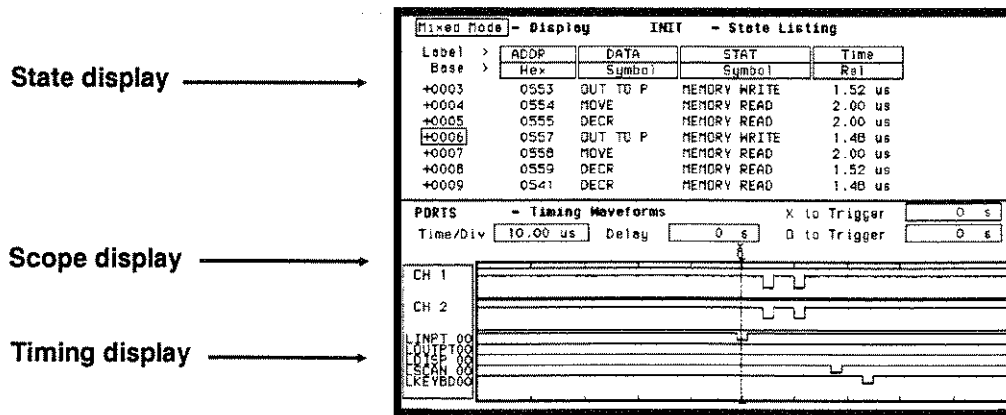

Figure 26-9. State/Timing/Scope Mixed Mode Display

The arming requirements for the oscilloscope are the same as in timing/scope mixed mode displays.

The procedure for inserting waveforms in the timing waveforms display is the same as in timing/scope mixed mode displays.

The markers for the state analyzer, timing analyzer and oscilloscope in time-correlated Mixed Mode are different from the markers in the individual waveforms and listing displays. You will need to place the markers on your points of interest in the time-correlated Mixed Mode even though you have placed them in the individual displays

---

## Time-Correlated Displays

The HP1652B/1653B Logic Analyzers can time-correlate data between the timing analyzer and the state analyzer (see Timing/State Mixed Mode Display) between two state analyzers (see State/State Mixed Mode Display) and between the state analyzer, the timing analyzer and the scope (see State/Timing And Scope Mixed Mode Display).

The logic analyzer uses a counter to keep track of the time between the triggering of one analyzer and the triggering of the second. It uses this count in the mixed mode displays to reconstruct time-correlated data.

To summarize time-correlation between the different displays, remember the following.

To time-correlate the state analyzer display to the timing analyzer display, **arm the timing analyzer** with the state analyzer, then set the state analyzer count mode to **Time**.

Then, to add the scope display, **arm the scope** with the timing analyzer and set the scope to trigger **Immediate**.

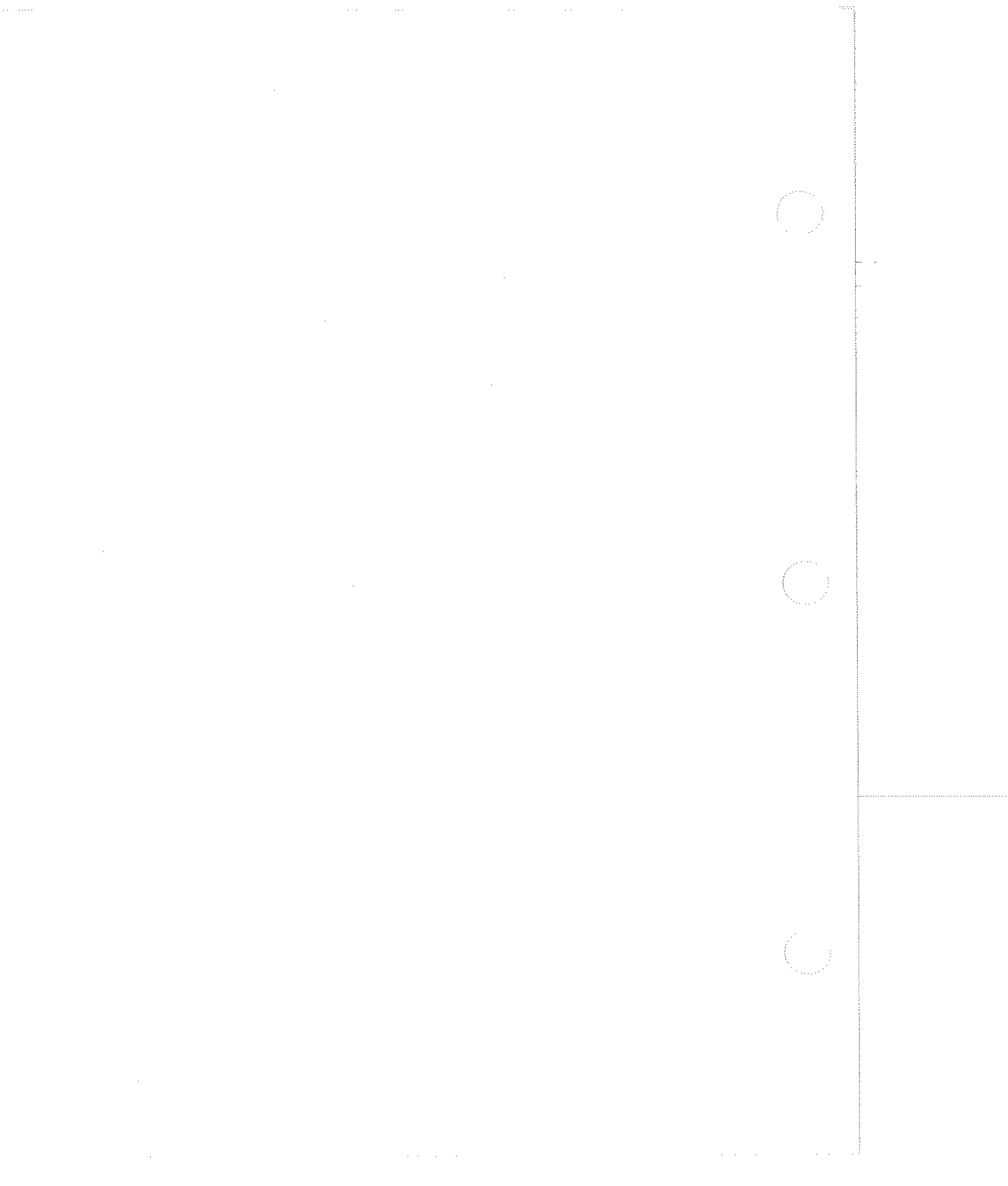

## Timing/State/Oscilloscope Measurement Example

### Introduction

In this chapter you will learn how to use the timing analyzer, state analyzer, and oscilloscope interactively by setting up the logic analyzer menus to simulate the process of making a measurement. We will give you the measurement results, as actually measured by the logic analyzer, since you will not have the exact same circuit available.

This measurement example uses an HP 1652B (five pods). The steps for setting up the analyzer menus are ordered in a manner you would naturally take if you were actually troubleshooting this problem.

Since you've already had some practice at setting up both the timing and state analyzers in previous examples, you should be able to setup the analyzer menus by looking at the pictures. If you can set up each menu by just looking at the menu pictures, go ahead and do so. If you need a reminder of what steps to perform, follow the numbered steps.

### Problem Solving with the Timing/State/Scope Analyzer

In this example assume you have a microprocessor-controlled circuit that sequentially accesses five ports and reports back any that do not respond correctly. After power-up, the system indicates that two of the ports are not responding. The block diagram shown below helps to illustrate the system under test and its problem.

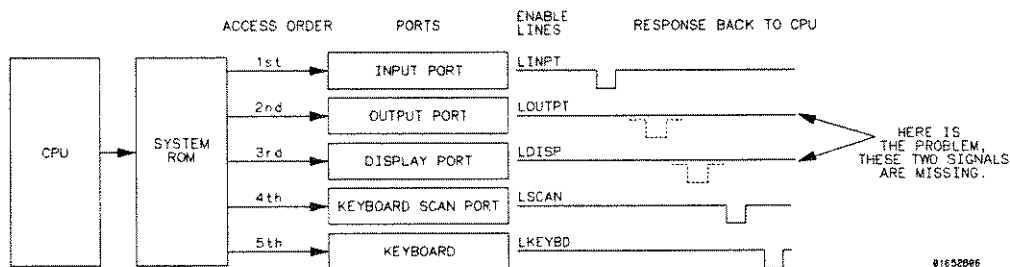

Figure 27-1. System Under Test With Problem

## What Am I Going to Measure?

The circuit under test is actually hardware being controlled by firmware. The code stored in the system ROM (Read Only Memory) could be faulty, or there could be a hardware problem, such as a bad IC or shorts/opens on the PC board.

Your measurement should verify the following:

- Whether the code in system ROM is correct.
- Whether the ICs are functioning properly.
- Whether any board shorts/opens exist.

Before you begin your troubleshooting process, you should recognize the strengths of your tools.

1. Your state analyzer can look at the actual code in ROM that controls the circuit operation. In addition, you can use the state analyzer to control (through arming and triggering) the starting point of all other measurements.
2. Your timing analyzer can verify the hardware has correctly translated the code in ROM into the five sequential enable signals with the required timing relationships.
3. Your oscilloscope can then look at any signal lines for closer examination of such thing as noise, spikes, slow pulse transitions, signal amplitude, and any open or shorted conditions.

The measurement sequence should follow the same order. First **verify the system code (state analyzer)**, then look at the **relationships between multiple signals (timing analyzer)**, then take a closer look at any unusual looking signal lines for the **final analysis (oscilloscope)**.

## How Do I Configure the Logic Analyzer?

The first part of your measurement is to verify that all 5 ports are initialized by the software in the power-up initialization routine. To do this, you will configure the logic analyzer as a state analyzer.

Configure the System Configuration menu as shown below, so Analyzer 1 is a state analyzer. For this example, the label INIT was chosen for you to describe the INITIALIZATION routine.

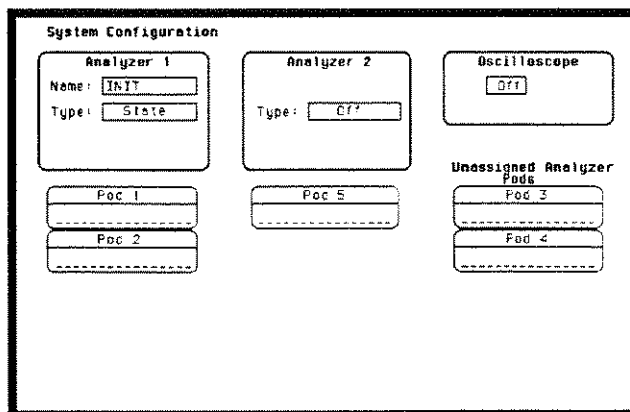

Figure 27-2. Set System Configuration Menu

1. Select **Type** field in Analyzer 1.
2. Select the **State** field.
3. Select **Pod 2** field and assign it to Analyzer 1.

## Configuring the State Analyzer

Now that you have configured the system, you are ready to configure the state analyzer. Set the State Format Specification menu as shown in figure 27-3. For this example, the labels ADDR, DATA, and STAT are chosen for you to describe address lines, data lines and CPU status.

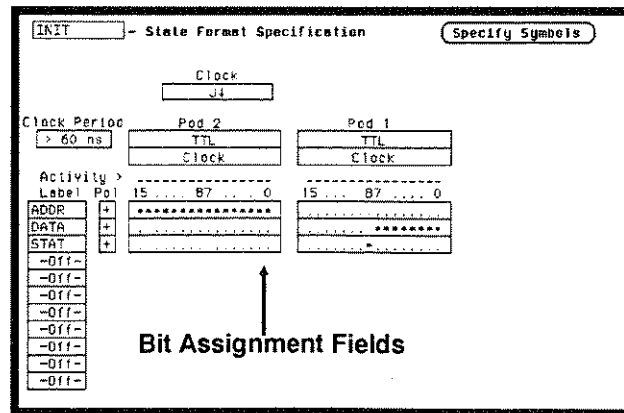

Figure 27-3. Configure the State Format Menu

1. Press FORMAT key on front panel.
2. Select Pod 2 (ADDR) bit assignment field and turn bits 0 through 15 on. These are the address lines.
3. Select Pod 1 (DATA) bit assignment field and turn bits 0 through 7 on. These are the data lines.
4. Select Pod 1 (STAT) bit assignment field and turn bit 8 on. This is the CPU Read/Write line.



You want the state analyzer to trigger and start storing states when it encounters the beginning of the initialization routine. This happens at the specific state (0550). To accomplish this, configure the State Trace Specification menu as shown below.

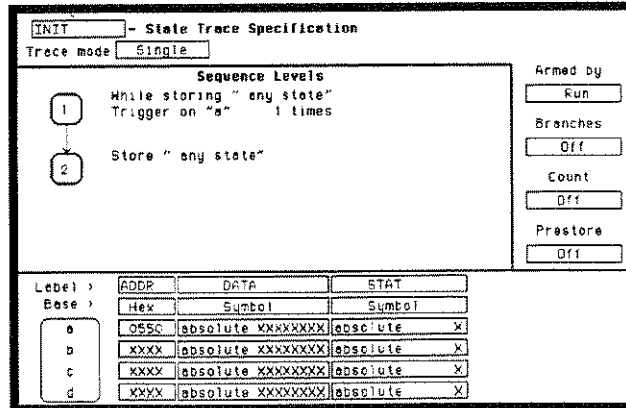

Figure 27-4. Configure the State Trace Menu

1. Press TRACE key on front panel.
2. Select the pattern field and insert the address you want the analyzer to trigger on (0550).

---

## Connecting the Probes

At this point, if you had a target system, you would connect the logic analyzer to your system. Since we have assigned labels ADDR, DATA and STAT, you would connect the probes to your system accordingly.

- Pod 1 probes 0 through 7 to the data bus lines D0 through D7
- Pod 1 probe 9 to the CPU Read/Write control line
- Pod 2 probes 0 through 15 to the address bus lines A0 through A15

---

## Acquiring the Data

You have configured the State Trace Specification menu to start acquiring data when the microprocessor sends address 0550 on the bus. When you press the RUN key, the state analyzer waits until it sees address 0550, then triggers itself, and completes the state data acquisition. The display will then switch automatically to the State Listing menu.

Note



We have assigned symbols for DATA and STAT in the State Listing display for you to better illustrate where the routine executes a memory write to the output ports.

---

example:    0550    OUT TO P    MEMORY WRITE

---

## Finding the Problem

You look at the state listing menu to see what the data is in states + 0000 through + 0013. These are the first stored states after trigger. You know your routine has five "OUT TO PORT" memory writes.

The microprocessor, does address the correct memory locations. Now you compare the data from the software engineer as listed below, with what is listed in the State Listing menu in figure 27-5.

```

0550    OUT TO PORT    MEMORY WRITE
0551    MOVE          MEMORY READ
0552    DECR          MEMORY READ
0553    OUT TO PORT    MEMORY WRITE
0554    MOVE          MEMORY READ
0555    DECR          MEMORY READ
0557    OUT TO PORT    MEMORY WRITE
0558    MOVE          MEMORY READ
0559    DECR          MEMORY READ
0541    DECR          MEMORY READ
0182    OUT TO PORT    MEMORY WRITE
0542    MOVE          MEMORY READ
0543    DECR          MEMORY READ
0544    OUT TO PORT    MEMORY WRITE
  
```

The screenshot shows a window titled "INIT - State Listing" with a "Markers" button set to "Off". Below is a table with the following columns: Label, Base, ADDR, DATA, STAT, and Time. The data rows correspond to the list provided in the text above.

Label	Base	ADDR	DATA	STAT	Time
		Hex	Symbol	Symbol	Rel
+0000		0550	OUT TO P	MEMORY WRITE	1.48 us
+0001		0551	MOVE	MEMORY READ	3.00 us
+0002		0552	DECR	MEMORY READ	2.00 us
+0003		0553	OUT TO P	MEMORY WRITE	1.52 us
+0004		0554	MOVE	MEMORY READ	2.00 us
+0005		0555	DECR	MEMORY READ	2.00 us
+0006		0557	OUT TO P	MEMORY WRITE	1.48 us
+0007		0558	MOVE	MEMORY READ	2.00 us
+0008		0559	DECR	MEMORY READ	1.52 us
+0009		0541	DECR	MEMORY READ	1.48 us
+0010		0182	OUT TO P	MEMORY WRITE	2.00 us
+0011		0542	MOVE	MEMORY READ	1.52 us
+0012		0543	DECR	MEMORY READ	2.00 us
+0013		0544	OUT TO P	MEMORY WRITE	1.48 us
+0014		0545	MOVE	MEMORY READ	2.00 us
+0015		059C	MOVE	MEMORY READ	3.00 us

Figure 27-5. State Listing Menu

Since the data stored in memory is correct, it's time to look at the hardware to see if it's causing problems during the initialization routine. You decide to look at the activity on the enable lines during this routine.

In order to see time domain measurements on hardware signals, you need the timing analyzer.

---

## **What Additional Measurements Must I Make?**

Since the problem exists during the routine that starts at address 0550, you decide to look at the timing waveforms on the enable lines when the routine is running.

Your measurement, then, requires verification of:

- actual response of enable lines from the five ports.
- correct timing of the responding enable lines.

## How Do I Re-configure the Logic Analyzer?

In order to make this measurement, you must re-configure the logic analyzer so Analyzer 2 is a timing analyzer. You leave Analyzer 1 as a state analyzer since you will use the state analyzer to trigger the timing analyzer.

Configure the logic analyzer so Analyzer 2 is a timing analyzer as shown below. For this example, the label PORTS was selected for you to describe the output ports.

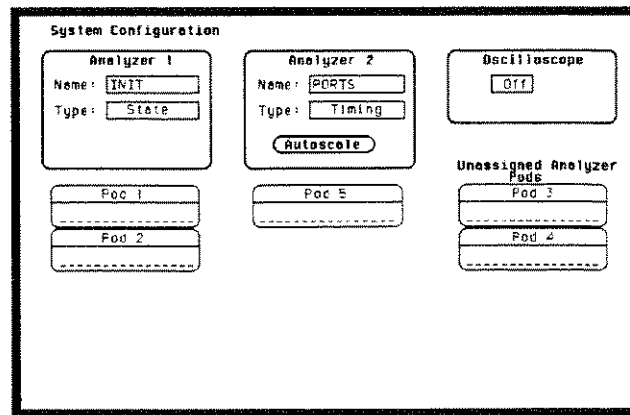

Figure 27-6. Re-configure System Configuration Menu

1. Select **Type** field in Analyzer 2.
2. Select the **Timing** field.

## Connecting the Timing Analyzer Probes

At this point you would connect the probes of pod 5 as follows:

- Pod 5 bit 1 to enable line LINPT.
- Pod 5 bit 2 to enable line LOUTPT.
- Pod 5 bit 3 to enable line LDISP.
- Pod 5 bit 4 to enable line LSCAN.
- Pod 5 bit 5 to enable line LKEYBD.

## Configuring the Timing Analyzer

Now that you have configured the system, you are ready to configure the timing analyzer. Configure the Timing Format Specification menu as shown below.

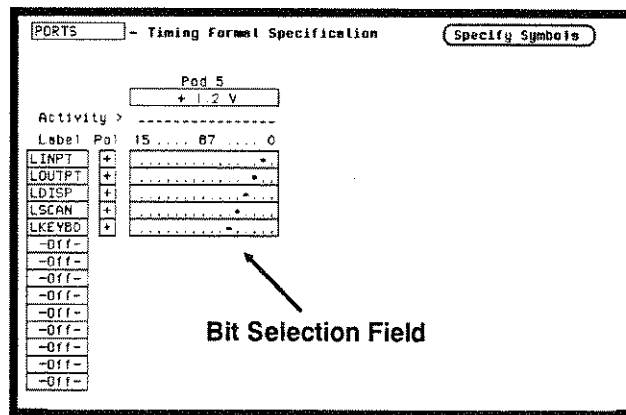

Figure 27-7. Configure the Timing Format Menu

1. Select the bit selection field.
2. Place the cursor on the appropriate bit and turn it on (asterisk \*).

## Setting the Timing Analyzer Trigger

Your timing measurement requires the timing analyzer to display the timing waveforms present on the enable lines when the routine is running. Since the state analyzer will trigger on address 0550, you will want to arm the timing analyzer with the state analyzer, so the timing waveforms will be captured at the same time.

- Configure the Timing Trace Specification menu as shown below.

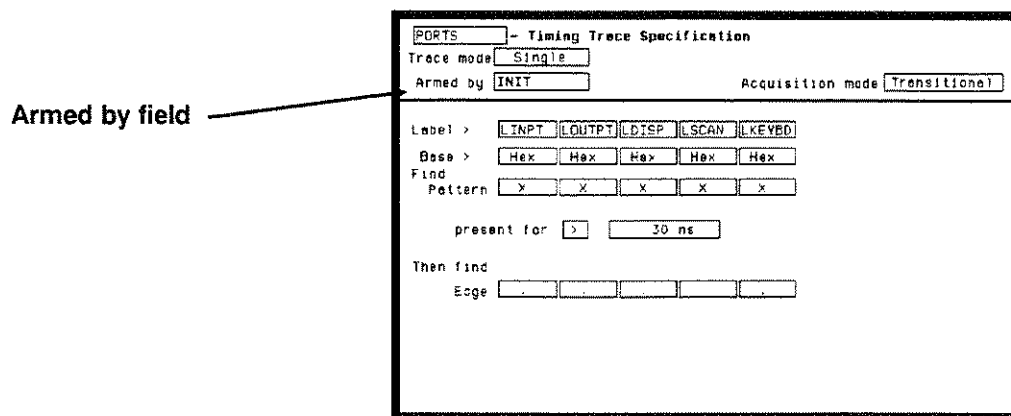

Figure 27-8. Set Armed By Field to INIT

1. Display the Timing Trace Specification menu.
2. Select the Armed by field.
3. Select the INIT (state analyzer) option in the pop-up.

## Time Correlating the Data

In order to time correlate the data, the logic analyzer must store the timing relationships between states. Since the timing analyzer samples asynchronously and the state analyzer samples synchronously, the logic analyzer must use the stored timing relationship of the data to reconstruct a time correlated display.

Configure the State Trace Specification menu as shown below:

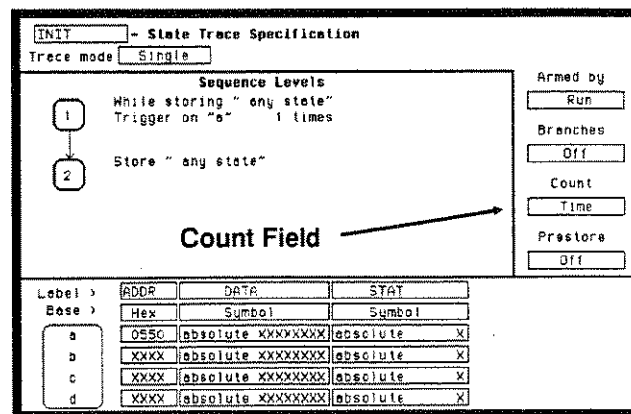

Figure 27-9. Set Count to Time

1. Display the State Trace Specification menu.
2. Select the **Count** field.
3. Select the **Time** field and press the SELECT key. The counter will now be able to keep track of time between states, for the time correlation.



## Re-Acquiring the Data

With the timing analyzer configured and the probes of pod 5 connected to the circuit, all you have to do is press RUN. When the logic analyzer acquires the data it switches the display automatically to the Timing Waveforms menu, unless you switched to one of the other menus in the state analyzer after reconfiguring the Timing Trace menu. In that case, you will be in the State Listing menu. Regardless of which analyzer display menu you are in, you should now look at both analyzers together in the Mixed Mode Display.

## Mixed Mode Display

The Mixed mode display shows you both the State Listing and Timing Waveforms menus simultaneously. To change the display to the Mixed Mode:

1. Select the field in the upper left corner of the display and press the SELECT key.
2. Select the Mixed mode field. You will now see the Mixed Mode display as shown below.

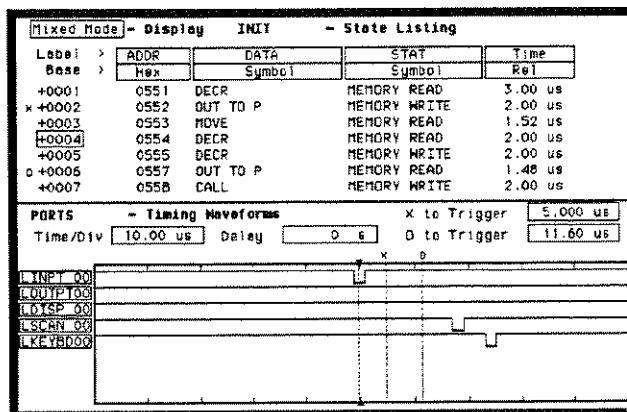

Figure 27-10. Mixed Mode Display

---

## Interpreting the Display

In the Mixed Mode display the state listing is in the top half of the screen and the timing waveforms are in the lower half. The important thing to remember is that you time correlated this display so you could see what is happening in timing during the initialization routine.

Notice that the trigger point in both parts of the display is the same as it was when the displays were separate. The trigger in the state listing is at state + 0000 and the trigger of the timing waveform is the vertical dotted line.

As you look at the Mixed Mode Display, you notice that two of the five sequential enable pulses are missing on the timing waveforms display. This is the problem you are looking for, but you still don't have enough information about what might be causing these two enable lines to be inactive. This is where a closer look with the scope may help.

---

## Re-configure the Analyzer with Scope

The two missing enable signals from the Timing Waveforms display show you where to look next. Before a pulse can be displayed, the voltage level must meet the threshold voltage requirements. To look at these enable lines closer, for a more detailed analysis of their voltage levels or any possible shorts or opens, you will use the oscilloscope.

Your measurement then requires the verification of the following:

- Signal voltage levels.
- Any possible shorted or open conditions.

Go back to the System Configuration menu and turn the Oscilloscope On as shown below.

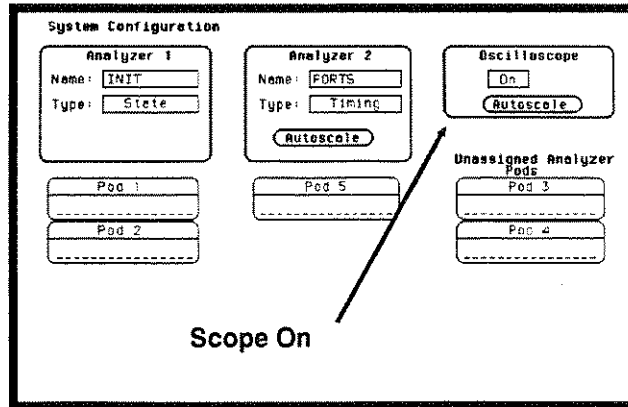

Figure 27-11. Re-configure with Scope

## Connecting the Scope Probes

Connect the scope probes to the two enable lines that show missing signals.

Channel one is connected to LOUTPT.  
Channel two is connected to LDISP.

## Arming the Scope

Before the scope signals can be time-correlated and combined with the Timing Waveforms display, the scope must be armed by the timing analyzer and set to trigger immediately.

Set the **Armed by** field and **Mode** field in the Trigger menu as shown below.

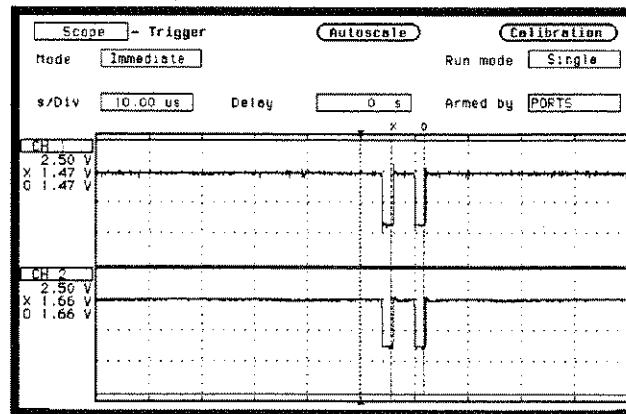

Figure 27-12. Set Armed by Field to PORTS

1. From the System Configuration menu, press the TRIG key. If you don't go to the scope Trigger menu, just select the upper left-most field and from there you can select the Scope field.
2. From the scope Trigger menu select the Armed by field.
3. From the pop-up select the PORTS field.
4. Select the Mode field and toggle to Immediate.

## Making the Scope Measurement

With the scope armed by PORTS (timing analyzer) and the probes connected to LOUTPT and LDISP enable lines, all you have to do is select RUN. The scope will automatically switch to the Waveforms display.

The state analyzer cross triggers the timing analyzer, which in turn, triggers the oscilloscope.

Set the s/Div to  $10\ \mu\text{s}$  and notice the double pulse and the voltage levels in the figure below.

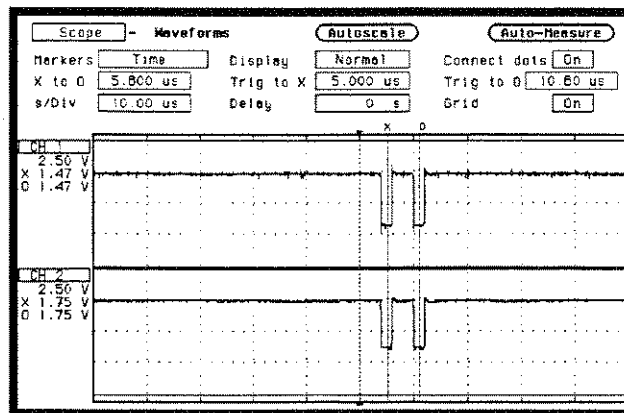

Figure 27-13. Scope Waveforms Display

You can examine the two enable lines in three different displays:

- Scope Waveforms.
- Timing Waveforms (scope channels can be added in).
- Mixed Mode Display.

## Mixed Mode Display with Scope

With three different measurements stored in memory, you can now get the total picture of your problem from the Mixed Mode display. As mentioned before, the scope must be armed by the timing analyzer and set to trigger Immediate before the time-correlated scope signals can be inserted into the Timing Waveforms display

Insert the scope waveforms into the Timing Waveforms display (the lower display in Mixed Mode) as shown below.

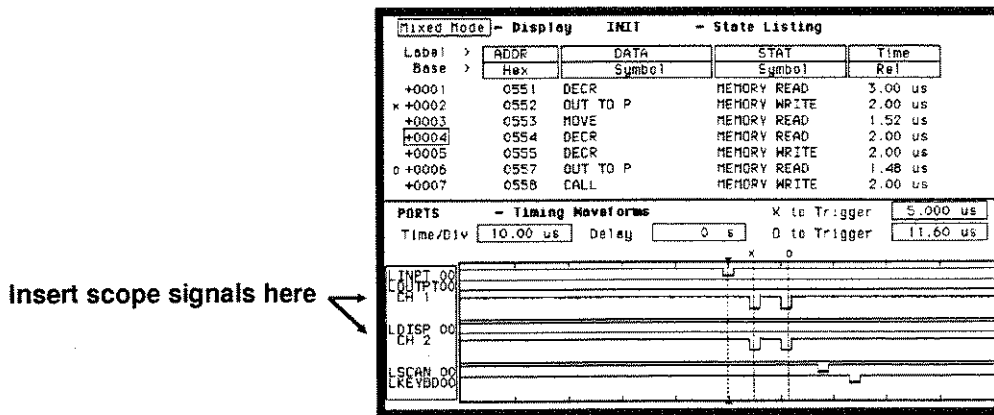

Figure 27-14. Mixed Mode Display

1. Select the upper-left most field and press the SELECT key.
2. From the pop-up select the Mixed Mode field.
3. From the Mixed Mode display menu, select the LOUTPT field and insert the scope's CH 1 waveform. The waveform should appear directly below LOUTPT.
4. Select the LDISP field and insert the scope's CH 2 waveform. The waveform should appear directly below LDISP.

---

## Finding the Answer

You notice two double pulses instead of two sequential pulses. Since they are identical, this could mean a short between them. Also, the voltage levels never falls below threshold voltage of the timing analyzer. This is why the pulses were not displayed by the timing analyzer. After futher examination of the pc board, you find a solder bridge shorting the two enable signals together.

---

## Summary

You have just learned how to use the timing and state analyzers interactively with the oscilloscope to find a problem that was not easily determined whether it was a software or hardware problem.

You have learned to do the following:

- Trigger one analyzer with the other.
- Time correlate measurement data.
- Interpret the Mixed mode display.

With three different measurements, time-correlated and displayed side by side, a complete analysis of this problem is done with the HP 1652B.





## **Microprocessor Specific Measurements**

---

### **Introduction**

This appendix contains information about the optional accessories available for microprocessor specific measurements. In depth measurement descriptions are included in the operating notes that come with each of these accessories. The accessories you will be introduced to in this appendix are the preprocessor modules and the HP 10269C General Purpose Probe Interface.

---

### **Microprocessor Measurements**

A preprocessor module enables you to quickly and easily connect the logic analyzer to your microprocessor under test. Most of the preprocessor modules require the HP 10269C General Purpose Probe Interface. The preprocessor descriptions in the following sections indicate which preprocessors require it.

Included with each preprocessor module is a 3.5-inch disk which contains a configuration file and an inverse assembler file. When you load the configuration file, it configures the logic analyzer for making state measurements on the microprocessor for which the preprocessor is designed. It also loads in the inverse assembler file.

The inverse assembler file is a software routine that will display captured information in a specific microprocessor's mnemonics. The DATA field in the State Listing is replaced with an inverse assembly field (see Figure A-1). The inverse assembler software is designed to provide a display that closely resembles the original assembly language listing of the microprocessor's software. It also identifies the microprocessor bus cycles captured, such as Memory Read, Interrupt Acknowledge, or I/O write.

Label		ADDR	Mnemonic	Time	STAT
Base		Hex	hex	Rel	Hex
-0002		0004F4	ORI.B #30,DC		2B
-0001		0004F6	B930 program read	1.24 us	2B
+0000		008930	CHP.B #FF,DC	1.2B us	30
+0001		008932	00FF program read	1.24 us	30
+0002		008934	BEQ.B 00B92E	1.24 us	30
+0003		008936	CHP.B ***,DC	1.24 us	30
+0004		00892E	BSR.B 00892A	1.76 us	30
+0005		008930	B03C unused prefetch	1.24 us	30
+0006		0004F4	0000 program write	2.00 us	29
+0007		0004F6	B930 program write	1.4B us	29
+0008		00892A	JMP 00B8C6(IFC)	1.2B us	30
+0009		00892C	FF9A program read	1.24 us	30
+0010		00B8C6	BSR.B 0088AE	1.72 us	30
+0011		00B8C8	B03C unused prefetch	1.2B us	30

Figure A-1. State Listing with Mnemonics

## Microprocessors Supported by Preprocessors

This section lists the microprocessors that are supported by Hewlett-Packard preprocessors and the logic analyzer model that each preprocessor requires. Most of the preprocessors require the HP 10269C General Purpose Probe Interface. The HP 10269C accepts the specific preprocessor PC board and connects it to five connectors on the general purpose interface to which the logic analyzer probe cables connect.

### Note



This appendix lists the preprocessors available at the time of printing. However, new preprocessors may become available as new microprocessors are introduced. Check with the nearest Hewlett-Packard sales office periodically for availability of new preprocessors.

**Z80** CPU Package: 40-pin DIP

Accessories Required: HP 10300B Preprocessor  
HP 10269C General Purpose Probe Interface

Maximum Clock Speed: 10 MHz clock input

Signal Line Loading: Maximum of one 74LS TTL load + 35 pF on  
any line

Microprocessor Cycles Identified: Memory read/write  
I/O read/write  
Opcode fetch  
Interrupt acknowledge  
RAM refresh cycles

Maximum Power Required: 0.3 A at + 5 Vdc, supplied by logic  
analyzer

Logic Analyzer Required: HP 1652B or HP 1653B

Number of Probes Used: Two 16-channel probes

**NSC 800** CPU Package: 40-pin DIP

Accessories Required: HP 10303B Preprocessor  
HP 10269C General Purpose Probe Interface

Maximum Clock Speed: 4 MHz clock input

Signal Line Loading: Maximum of one HCMOS load + 35 pF on any line

Microprocessor Cycles Identified: Memory read/write  
I/O read/write  
Opcode fetch  
Interrupt acknowledge  
RAM refresh cycles  
DMA cycles

Maximum Power Required: 0.1A at + 5 Vdc, supplied by logic analyzer

Logic Analyzer Required: HP 1652B or HP 1653B

Number of Probes Used: Two 16-channel probes

**8085** CPU Package: 40-pin DIP

Accessories Required: HP 10304B Preprocessor  
HP 10269C General Purpose Probe Interface

Maximum Clock Speed: 6 MHz clock output (12 MHz clock input)

Signal Line Loading: Maximum of one 74LS TTL load + 35 pF on any line

Microprocessor Cycle Identified: Memory read/write  
I/O read/write  
Opcode fetch  
Interrupt acknowledge

Maximum Power Required: 0.8 A at + 5 Vdc, supplied by logic analyzer

Logic Analyzer Required: HP 1652B or HP 1653B

Number of Probes Used: Two 16-channel probes

**8086 or 8088** CPU Package: 40-pin DIP

Accessories Required: HP 10305B Preprocessor  
HP 10269C General Purpose Probe Interface

Maximum Clock Speed: 10 MHz clock input (at CLK)

Signal Line Loading: Maximum of two 74ALS TTL loads + 40 pF on any line

Microprocessor Cycles Identified: Memory read/write  
I/O read/write  
Code fetch  
Interrupt acknowledge  
Halt acknowledge  
Transfer to 8087 or 8089 co-processors

Additional Capabilities: The 8086 or 8088 can be operating in Minimum or Maximum modes. The logic analyzer can capture all bus cycles (including prefetches) or can capture only executed instructions. To capture only executed instructions, the 8086 or 8088 must be operating in the Maximum mode.

Maximum Power Required: 1.0 A at + 5 Vdc, supplied by the logic analyzer

Logic Analyzer Required: HP 1652B

Number of Probes Used: Three 16-channel probes

**80186 or 80C186** CPU Package: 68-pin PGA

Accessories Required: HP 10306G Preprocessor

Maximum Clock Speed: 12.5 MHz clock output (25 MHz clock input)

Signal Line Loading: Maximum of 100 k $\Omega$  + 18 pF on any line

Microprocessor Cycles Identified: Memory read/write (DMA and non-DMA)  
I/O read/write (DMA and non-DMA)  
Code fetch  
Interrupt acknowledge  
Halt acknowledge  
Transfer to 8087, 8089,  
or 82586 co-processors

Additional Capabilities: The 80186 can be operating in Normal or Queue Status modes. The logic analyzer can capture all bus cycles (including prefetches) or can capture only executed instructions.

Maximum Power Required: 0.08 A at + 5 Vdc, supplied system under test.

Logic Analyzer Required: HP 1652B

Number of Probes Used: Four 16-channel probes

**80286** CPU Package: 68-contact LCC or 68-pin PGA

Accessories Required: HP 10312D Preprocessor  
HP 10269C General Purpose Probe Interface

Maximum Clock Speed: 10 MHz clock output (20 MHz clock input)

Signal Line Loading: Maximum of two 74ALS TTL loads + 40 pF on any line

Microprocessor Cycles Identified: Memory read/write  
I/O read/write  
Code fetch  
Interrupt acknowledge  
Halt  
Hold acknowledge  
Lock  
Transfer to 80287 co-processor

Additional Capabilities: The logic analyzer captures all bus cycles including prefetches

Maximum Power Required: 0.66 A at + 5 Vdc, supplied by logic analyzer. 80286 operating current from system under test.

Logic Analyzer Required: HP 1652B

Number of Probes Used: Three 16-channel probes



**80386** CPU Package: 132-pin PGA

Accessories Required: HP 10314D Preprocessor  
HP 10269C General Purpose Probe Interface

Maximum Clock Speed: 33 MHz clock output (66 MHz clock input)

Signal Line Loading: Maximum of two 74ALS TTL loads + 35 pF on any line

Microprocessor Cycles Identified: Memory read/write  
I/O read/write  
Code fetch  
Interrupt acknowledge, type 0-255  
Halt  
Shutdown  
Transfer to 8087, 80287, or 80387 co-processors

Additional Capabilities: The logic analyzer captures all bus cycles including prefetches

Maximum Power Required: 1.0 A at + 5 Vdc, supplied by logic analyzer

Logic Analyzer Required: HP 1652B

Number of Probes Used: Five 16-channel probes

**6800 or 6802** CPU Package: 40-pin DIP

Accessories Required: HP 10307B Preprocessor  
HP 10269C General Purpose Probe Interface

Maximum Clock Speed: 2 MHz clock input

Signal Line Loading: Maximum of 1 74LS TTL load + 35 pF on any line

Microprocessor Cycle Identified: Memory read/write  
DMA read/write  
Opcode fetch/operand  
Subroutine enter/exit  
System stack push/pull  
Halt  
Interrupt acknowledge  
Interrupt or reset vector

Maximum Power Required: 0.8A at + 5 Vdc, supplied by logic analyzer

Logic Analyzer Required: HP 1652B or HP 1653B

Number of Probes Used: Two 16-channel probes

**6809 or 6809E** CPU Package: 40-pin DIP

Accessories Required: HP 10308B Preprocessor  
HP 10269C General Purpose Probe Interface

Maximum Clock Speed: 2 MHz clock input

Signal Line Loading: Maximum of one 74ALS TTL load + 35 pF on any line

Microprocessor Cycles Identified: Memory read/write  
DMA read/write  
Opcode fetch/operand  
Vector fetch  
Halt  
Interrupt

Additional Capabilities: The preprocessor can be adapted to 6809/09E systems that use a Memory Management Unit (MMU). This adaptation allows the capture of all address lines on a physical address bus up to 24 bits wide.

Maximum Power Required: 1.0 A at + 5 Vdc, supplied by logic analyzer

Logic Analyzer Required: HP 1652B or HP 1653B

Number of Probes Used: Two 16-channel probes

**68008** CPU Package: 40-pin DIP

Accessories Required: HP 10310B Preprocessor  
HP 10269C General Purpose Probe Interface

Maximum Clock Speed: 10 MHz clock input

Signal Line Loading: Maximum of one 74S TTL load + one 74F TTL  
load + 35 pF on any line

Microprocessor Cycles Identified: User data read/write  
User program read  
Supervisor read/write  
Supervisor program read  
Interrupt acknowledge  
Bus grant  
6800 cycle

Additional Capabilities: The logic analyzer captures all bus cycles  
including prefetches

Maximum Power Required: 0.4 A at + 5 Vdc, supplied by logic  
analyzer

Logic Analyzer Required: HP 1652B

Number of Probes Used: Three 16-channel probes

**68000 and 68010  
(64-pin DIP)**

CPU Package: 64-pin DIP

Accessories Required: HP 10311B Preprocessor  
HP 10269C General Purpose Probe Interface

Maximum Clock Speed: 12.5 MHz clock input

Signal Line Loading: Maximum of one 74S TTL load + one 74F  
TTL load + 35 pF on any line

Microprocessor Cycles Identified: User data read/write  
User program read  
Supervisor read/write  
Supervisor program read  
Interrupt acknowledge  
Bus Grant  
6800 cycle

Additional Capabilities: The logic analyzer captures all bus cycles  
including prefetches

Maximum Power Required: 0.4 A at + 5 Vdc, supplied by the logic  
analyzer

Logic Analyzer Required: HP 1652B

Number of Probes Used: Three 16-channel probes

**68000 and 68010  
(68-pin PGA)**

CPU Package: 68-pin PGA

Accessories Required: HP 10311G Preprocessor

Maximum Clock Speed: 12.5 MHz clock input

Signal Line Loading: 100 k $\Omega$  + 10 pF on any line

Microprocessor Cycles Identified: User data read/write  
User program read  
Supervisor read/write  
Supervisor program read  
Interrupt acknowledge  
Bus Grant  
6800 cycle

Additional Capabilities: The logic analyzer captures all bus cycles including prefetches.

Maximum Power Required: None

Logic Analyzer Required: HP 1652B

Number of Probes Used: Three 16-channel probes

**68020** CPU Package: 114-pin PGA

Accessories Required: HP 10313G

Maximum Clock Speed: 25 MHz clock input

Signal Line Loading: 100 k $\Omega$  + 10 pF on any line

Microprocessor Cycles Identified: User data read/write  
User program read  
Supervisor read/write  
Supervisor program read  
Bus Grant  
CPU space accesses including:  
Breakpoint acknowledge  
Access level control  
Coprocesor communication  
Interrupt acknowledge

Additional Capabilities: The logic analyzer captures all bus cycles including prefetches. The 68020 microprocessor must be operating with the internal cache memory disabled for the logic analyzer to provide inverse assembly.

Maximum Power Required: None

Logic Analyzer Required: HP 1652B

Number of Probes Used: Five 16-channel probes

**68030** CPU Package: 128-pin PGA

Accessories Required: HP 10316G

Maximum Clock Speed: 25 MHz input

Signal Line Loading: 100K $\Omega$  plus 18 pF on all lines except DSACK0 and DSACK1.

Microprocessor Cycles Identified: User data read/write  
User program read  
Supervisor program read  
Bus grant  
CPU space accesses including:  
Breakpoint acknowledge  
Access level control  
Coprocessor communication  
Interrupt acknowledge

Additional Capabilities: The logic analyzer captures all bus cycles, including prefetches. The 68030 microprocessor must be operating with the internal cache memory and MMU disabled for the logic analyzer to provide inverse assembly.

Maximum Power Required: None

Logic Analyzer Required: HP 1652B

Number of Probes Used: Five 16-channel probes



**68HC11** CPU Package: 48-pin dual-in-line

Accessories Required: HP 10315G

Maximum Clock Speed: 8.4 MHz input

Signal Line Loading: 100K $\Omega$  plus 12 pF on all lines.

Microprocessor Cycles Identified: Data read/write  
Opcode/operand fetches  
Index offsets  
Branch offsets  
Irrelevant cycles

Additional Capabilities: The 68HC11 must be operating in the expanded multiplexed mode (addressing external memory and/or peripheral devices) for the logic analyzer to provide inverse assembly.

Maximum Power Required: None

Logic Analyzer Required: HP 1652B or HP1553B

Number of Probes Used: Two 16-channel probes for state analysis and one to four for timing analysis.

---

## Loading Inverse Assembler Files

You load the inverse assembler file by loading the appropriate configuration file. Loading the configuration file automatically loads the inverse assembler file.

---

## Selecting the Correct File

Most inverse assembler disks contain more than one file. Each disk usually contains an inverse assembler file for use with the HP 10269C and preprocessor as well as a file for general purpose probing. Each inverse assembler filename has a suffix which indicates whether it is for the HP 10269C and preprocessor or general purpose probing. For example, filename C68000\_I indicates a 68000 inverse assembler file for use with the HP 10269C and the 68000 preprocessor. Filename C68000\_P is for general purpose probing. Specific file descriptions and recommended usage are contained in each preprocessor operating note.

---

## Loading the Desired File

To load the inverse assembler file you want, insert the 3.5-inch disk you received with your preprocessor in the disk drive. Select the I/O menu. In the I/O menu, select DISK OPERATIONS. The logic analyzer will read the disk and display the disk directory.

Select the Load option and place the filename you want to load in the "from file" box. Place the cursor on Execute and press SELECT.

Place the cursor on the analyzer you want the file loaded into and press SELECT. An advisory "Loading file from disk" is displayed. When the logic analyzer has finished loading the file, you will see "Load operation complete."

The file is now loaded and the logic analyzer is configured for disassembly of acquired data.

---

## Connecting the Logic Analyzer Probes

The specific preprocessor and inverse assembler you are using determines how you connect the logic analyzer probes. Since the inverse assembler files configure the System Configuration, State Format Specification, and State Trace Specification menus, you must connect the logic analyzer probe cables accordingly so that the acquired data is properly grouped for inverse assembly. Refer to the specific inverse assembler operating note for the proper connections.

---

## How to Display Inverse Assembled Data

The specific preprocessor and inverse assembler you are using determines how the inverse assembled data is displayed. When you press RUN, the logic analyzer acquires data and displays the State Listing menu.

The State Listing menu will display as much information about the captured data as possible. For some microprocessors, the display will show a completely disassembled state listing.

Some of the preprocessors and/or the microprocessors under test do not provide enough status information to disassemble the data correctly. In this case, you will need to specify additional information (i.e., tell the logic analyzer what state contains the first word of an opcode fetch). When this is necessary an additional field (INVASM) will appear in the top center of the State Listing menu (see below). This field allows you to point to the first state of an Op Code fetch.

```
68000STATE - State Listing  Invasm  Minimum X-0: 0 s
Markers Statistics  Valid runs:  Maximum X-0: 0 s
                          16 of 16  Average X-0: 0 s
```

**Figure A-2. Inverse Assemble Field**

For complete details refer to the Operating Note for the specific preprocessor.



## Automatic Measurement Algorithms

---

### Introduction

One of the HP 1652B/1653B's primary oscilloscope features is its ability to make parametric measurements. This appendix provides details on how automatic measurements are performed and some tips on how to improve automatic measurement results.

### Measurement Setup

Measurements typically should be made at the fastest possible sweep speed to obtain the most measurement accuracy possible. For any measurement to be made, the portion of the waveform required for that measurement must be displayed on the oscilloscope:

- At least one complete cycle must be displayed for period or frequency measurements.
- The entire pulse must be displayed for pulse width measurements.
- The leading (rising) edge of the waveform must be displayed for risetime measurements.
- The trailing (falling) edge of the waveform must be displayed for falltime measurements.

### Making Measurements

If more than one waveform, edge, or pulse is displayed, the measurements are made on the first (leftmost) portion of the displayed waveform that can be used. When any of the defined measurements are requested, the oscilloscope first determines the top (100%) and base (0%) voltages of the waveform. From this information, it can determine the other important voltage values (10% voltage, 90% voltage, and 50% voltage) required to make the measurements. The 10% and 90% voltage values are used in the risetime and falltime measurements. The 50% voltage value is used for measuring frequency, period, pulse width, and duty cycle.

---

## Top and Base Voltages

All measurements except  $V_{p-p}$  are calculated using the  $V_{top}$  (100% voltage) and  $V_{base}$  (0% voltage) levels of the displayed waveform. The  $V_{top}$  and  $V_{base}$  levels are determined from an occurrence density histogram of the data points displayed on screen.

The digitizing oscilloscope displays 6-bit vertical voltage resolution. This means the vertical display is divided up into 64 voltage levels. Each of these 64 levels is called a quantization level. Each waveform has a minimum of 500 data points displayed horizontally on screen. Each of these data point sets have one quantization level assigned to it. The histogram is calculated by adding the number of occurrences of each quantization level of the displayed data point sets on the displayed waveform.

The quantization level with the greatest number of occurrences in the top half of the waveform corresponds to the  $V_{top}$  level. The quantization level with the greatest number of occurrences in the bottom half of the waveform corresponds to the  $V_{base}$  level.

If  $V_{top}$  and  $V_{base}$  do not contain at least 5% of the minimum (500) data points displayed on screen,  $V_{top}$  defaults to the maximum voltage ( $V_{maximum}$ ) and  $V_{base}$  defaults to the minimum voltage ( $V_{minimum}$ ) found on the display. An example of this case would be measurements made on sine or triangle waves.

From this information the instrument can determine the 10, 50, and 90% points, which are used in most automatic measurements. The  $V_{top}$  or  $V_{base}$  of the waveform is not necessarily the maximum or minimum voltage present on the waveform. If a pulse has a slight amount of overshoot, it would be wrong to select the highest peak of the waveform as the top since the waveform normally rests below the perturbation.

---

## Measurement Algorithms

The following is a condensed explanation of the automatic measurements discussed in chapter 25.

### Frequency (Freq)

The frequency of the first complete cycle displayed is measured using the 50% levels.

If the first edge on the display is rising then

$$\text{Freq} = 1/(\text{trising edge 2} - \text{trising edge 1})$$

If the first edge on the display is falling then

$$\text{Freq} = 1/(\text{tfalling edge 2} - \text{tfalling edge 1})$$

### Period

The period is measured at the 50% voltage level of the waveform.

If the first edge on the display is rising then

$$\text{Period} = \text{trising edge 2} - \text{trising edge 1}$$

If the first edge on the display is falling then

$$\text{Period} = \text{tfalling edge 2} - \text{tfalling edge 1}$$

### Peak-to-Peak Voltage (Vp\_p)

The maximum and minimum voltages for the selected source are measured.

$$V_{p\_p} = V_{\text{maximum}} - V_{\text{minimum}}$$

where  $V_{\text{maximum}}$  and  $V_{\text{minimum}}$  are the maximum and minimum voltages present on the selected source.

**Positive Pulse width (+Width)** Pulse width is measured at the 50% voltage level. If the first edge on the display is rising then

$$+ \text{Width} = t_{\text{falling edge 1}} - t_{\text{rising edge 1}}$$

If the first edge on the display is falling then

$$+ \text{Width} = t_{\text{falling edge 2}} - t_{\text{rising edge 1}}$$

**Negative Pulse width (-Width)** Negative pulse width is the width of the first negative pulse on screen using the 50% levels.

If the first edge on the display is rising then

$$- \text{Width} = t_{\text{rising edge 2}} - t_{\text{falling edge 1}}$$

If the first edge on the display is falling then

$$- \text{Width} = t_{\text{rising edge 1}} - t_{\text{falling edge 1}}$$

**Risetime** The risetime of the first displayed rising edge is measured. To obtain the best possible measurement accuracy, set the sweep speed as fast as possible while leaving the leading edge of the waveform on the display. The risetime is determined by measuring time at the 10% and 90% voltage points on the rising edge.

$$\text{Risetime} = t_{90\%} - t_{10\%}$$

**Falltime** Falltime is measured between the 10% and 90% points of the falling edge. To obtain the best possible measurement accuracy, set the sweep speed as fast as possible while leaving the falling edge of the waveform on the display.

$$\text{Falltime} = t_{10\%} - t_{90\%}$$



## **Preshoot and Overshoot**

Preshoot and Overshoot measure the perturbation on a waveform above or below the top and base voltages (see "Top and Base Voltages" section earlier in this appendix). These measurements use all data displayed on screen, therefore it is very important that only the data of interest be displayed. If you want to measure preshoot and overshoot on one edge of a waveform, then only display that edge. If you want to measure the maximum preshoot and overshoot on a waveform, then display several cycles of the waveform.

**Preshoot** is a perturbation before a rising or a falling edge and is measured as a percentage of the top-base voltage.

**Overshoot** is a perturbation after a rising or a falling edge and is measured as a percentage of the top-base voltage

If the measured edge is rising then

$$\text{Preshoot} = \left[ \frac{V_{\text{base}} - V_{\text{minimum}}}{V_{\text{top-base}}} \right] \times 100$$

$$\text{Overshoot} = \left[ \frac{V_{\text{maximum}} - V_{\text{top}}}{V_{\text{top-base}}} \right] \times 100$$

If the measured edge is falling then:

$$\text{Preshoot} = \left[ \frac{V_{\text{maximum}} - V_{\text{top}}}{V_{\text{top-base}}} \right] \times 100$$

$$\text{Overshoot} = \left[ \frac{V_{\text{base}} - V_{\text{minimum}}}{V_{\text{top-base}}} \right] \times 100$$

**Duty Cycle** The positive pulse width and the period of the displayed signal are measured.

$$\text{duty cycle} = (+ \text{ pulse width/period}) \times 100$$

**rms Voltage** The rms voltage is computed over one complete period.

**Average Voltage** The average voltage of the first cycle of the displayed signal is measured. If a complete cycle is not present, the instrument will average the data points on screen.

## Error Messages

---

### Introduction

This appendix lists the error messages that require corrective action to restore proper operation of the logic analyzer. There are several messages that you will see that are merely advisories and are not listed here. For example, "Load operation complete" is one of these advisories.

The messages are listed in alphabetical order and in bold type.

**Acquisition aborted.** This message is displayed whenever data acquisition is stopped.

**At least one edge is required.** A state clock specification requires at least one clock edge. This message only occurs if you turn off all edges in the state clock specification.

**Autoload file not of proper type.** This message is displayed if any file other than an HP 1652B/1653B configuration file is specified for an autoload file and the logic analyzer is powered up.

**Autoscale aborted.** This message is displayed when the STOP key is pressed or if a signal is not found 15 seconds after the initiation of autoscale.

**BNC is being used as an ARM IN and cannot be used as an ARM OUT.** This message is displayed when BNC arms machine 1 (or 2), machine 1 (or 2) arms machine 2 (or 1), and the BNC is specified as ARM OUT. It will not occur if BNC arms machine 1 (or 2), and machine 1 (or 2) arms BNC.

**Configuration not loaded.** Indicates a bad configuration file. Try to reload the file again. If the configuration file will still not load, a new disk and/or configuration file is required.

**Copy operation complete.** Indicates the copy operation has either successfully completed or has been stopped.

**Correlation counter overflow.** The correlation counter overflows when the time from when one machine's trigger to the second machine's trigger exceeds the maximum count. It may be possible to add a "dummy" state to the second machine's trigger specification that is closer in time to the trigger of the first machine.

**Data can not be correlated-Time count need to be turned on.** "Count" must be set to "Time" in both machines to properly correlate the data.

**Destination write protected-file not copied.** Make sure you are trying to copy to the correct disk. If so, set the write protect tab to the non-protect position and repeat the copy operation.

**File not copied to disc-check disc.** The HP 1652B/1653B does not support track sparing. If a bad track is found, the disk is considered bad. If the disk has been formatted elsewhere with track sparing, the HP 1652B/1653B will only read up to the first spared track.

**Hardware ERROR: trace point in count block.** Indicates the data from the last acquisition is not reliable and may have been caused by a hardware problem. Repeat the data acquisition to verify the condition. If this message re-appears, the logic analyzer requires the attention of service personnel.

**Insufficient memory to load IAL - load aborted.** This message indicates that there is not a block of free memory large enough for the inverse assembler you are attempting to load even though there may be enough memory in several smaller blocks. Try to load the inverse assembler again. If this load is unsuccessful, load the configuration and inverse assembler separately.

**Invalid file name. Check the file name.** A file name must start with an alpha character and cannot contain spaces or slashes (/).

**Inverse assembler not loaded-bad object code.** Indicates a bad inverse assembler file on the disc. A new disc or file is required.

**Maximum of 32 channels per label.** Indicates an attempt to assign more than 32 channels to a label. Reassign channels so that no more than 32 are assigned to a label.

**No room on destination-file not copied.** Indicates the destination disc doesn't have enough room for the file you are attempting to copy. Try packing the disc and repeating the copy operation. If this is unsuccessful, you will need to use a different disc.

**(x) Occurrences Remaining in Sequence.** Indicates the logic analyzer is waiting for (x) number of occurrences in a sequence level of the trigger specification before it can go on to the next sequence level.

**PRINT has been stopped.** This message appears when the print operation has been stopped.

**(x) Secs Remaining in Trace.** Indicates the amount of time remaining until acquisition is complete in Glitch mode.

**Search failed - O pattern not found.** Indicates the O pattern does not exist in the acquired data. Check for a correct O marker pattern specification.

**Search failed - X pattern not found.** Indicates the X pattern does not exist in the acquired data. Check for a correct X marker pattern specification.

**Slow Clock or Waiting for Arm.** Indicates the state analyzer is waiting for a clock or arm from the other machine. Recheck the state clock or arming specification.

**Slow or missing Clock.** Indicates the state analyzer has not recognized a clock for 100 ms. Check for a missing clock if the intended clock is faster than 100 ms. If clock is present but is slower than 100 ms, the data will still be acquired when a clock is recognized and should be valid.

**Specified inverse assembler not found.** Indicates the inverse assembler specified cannot be found on the disk.

**State clock violates overdrive specification.** Indicates the data from the last acquisition is not reliable due to the state clock signal not being reliable. Check the clock threshold for proper setting and the probes for proper grounding.

**States Remaining to Post Store.** Indicates the number of states required until memory is filled and acquisition is complete.

**Time count need to be turned on.** This message appears when the logic analyzer attempts to time correlate data and "Count" is not set to "Time."

**Transitions Remaining to Post Store.** Indicates the number of transitions required until memory is filled and acquisition is complete.

**Unsupported destination format-file not copied.** Indicates the disk you have attempted to copy to is either not formatted or formatted in a format not used by the logic analyzer. Format the disk or use a properly formatted disk and repeat the copy operation.

**Value out of range. Set to limit.** Indicates an attempt to enter a value that is out of range for the specific variable. The logic analyzer will set the value to the limit of the variable range automatically.

**Waiting for Arm.** Indicates the arming condition has not occurred.

**Waiting for Prestore.** Indicates the prestore condition has not occurred.

**Waiting for Trigger.** Indicates the trigger condition has not occurred.

**Warning: Chips not successfully running.** Indicates the acquisition chips in the logic analyzer are not running properly. Press STOP and then RUN again. If the warning message reappears, refer the logic analyzer to service personnel.

**Warning: Chips not successfully stopped.** Indicates the acquisition chips in the logic analyzer are not stopping properly. Press RUN and then STOP again. If the warning message reappears, refer the logic analyzer to service personnel.

**Warning: Duplicate label name.** Indicates an attempt to assign an existing name to a new label.

**Warning: Duplicate symbol name.** Indicates an attempt to assign an existing name to a new symbol.

**Warning: Invalid file type.** Indicates an attempt to load an invalid file type. For example, the SYSTEM file can only be loaded on power-up and if you attempt to load it from the I/O menu, this message will appear.

**Warning: No clock edge in other clock, add clock edge.** This message only occurs in a state analyzer using mixed or demultiplexed clocks. It indicates there is no edge specified in either the master or slave clock. There must be at least one edge in each of the clocks.

**Warning: Symbol memory full. Max 200 symbols.** Indicates an attempt to store more than 200 symbols.

**Warning: Run HALTED due to variable change.** Indicates a variable has been changed during data acquisition in the continuous trace mode. The data acquisition will be halted and this message will be displayed when any variable affecting the system configuration, clock thresholds, clock multiplexing, or trace specification menus is changed during data acquisition.





## **Installation, Maintenance and Calibration**

---

### **Introduction**

This appendix contains information and instructions necessary for preparing the HP 1652B/1653B Logic Analyzers for use. Included in this section are inspection procedures, power requirements packaging information, and operating environment. It also tells you how to load the operating system and turn the logic analyzer on. Also included in this appendix is information on calibration and maintenance that you can do as an operator.

---

### **Initial Inspection**

Inspect the shipping container for damage. If the shipping container or cushioning material is damaged, it should be kept until the contents of the shipment have been checked for completeness and the instrument has been checked mechanically and electrically. Accessories supplied with the instrument are listed under "Accessories Supplied" in chapter 1 of this manual. An overview of the self-test procedure is in Appendix E of this manual. The complete details of the procedure are in Chapter 6 of the Service manual. Electrical performance verification functions are also in Chapter 3 of the Service Manual.

If the contents are incomplete, if there is mechanical damage or defect, or if the instrument does not pass the Self Test Performance Verification, notify the nearest Hewlett-Packard Office. If the shipping container is damaged, or the cushioning materials show signs of stress, notify the carrier as well as the Hewlett-Packard Office. Keep all shipping materials for the carrier's inspection. The Hewlett-Packard office will arrange for repair or replacement at HP option without waiting for claim settlement.

---

## Operating Environment

You may operate your logic analyzer in a normal lab or office type environment without any additional considerations. If you intend to use it in another type of environment, refer to Appendix F for complete operating environment specifications. Note the humidity limitation. Condensation within the instrument cabinet can cause poor operation or malfunction. Protection should be provided against temperature extremes which cause condensation.

### Ventilation

You must provide an unrestricted airflow for the fan and ventilation openings in the rear of the logic analyzer. However, you may stack the logic analyzer under, over, or in-between other instruments as long the surfaces of the other instruments are not needed for their ventilation.

---

## Storage and Shipping

This instrument may be stored or shipped in environments within the following limitations:

- Temperature: - 40 ° C to + 75 ° C
- Humidity: Up to 90% at 65 ° C
- Altitude: Up to 15,300 metres (50,000 feet)

### Tagging for Service

If the instrument is to be shipped to a Hewlett-Packard office for service or repair, attach a tag to the instrument identifying owner address of owner, complete instrument model and serial numbers and a description of the service required.

### Original Packaging

If the original packaging material is unavailable or unserviceable materials identical to those used in factory packaging are available through Hewlett-Packard offices. If the instrument is to be shipped to a Hewlett-Packard office for service, tag the instrument (see "Tagging for Service"). Mark the container FRAGILE to ensure careful handling. In any correspondence, refer to the instrument by model number and full serial number.

## Other Packaging

The following general instructions should be followed for repacking with commercially available materials.

- a. Wrap the instrument in heavy paper or plastic.
- b. Use a strong shipping container. A double-wall carton made of 350 lb. test material is adequate.
- c. Use a layer of shock-absorbing material 70 to 100 mm (3 to 4 inches) thick around all sides of the instrument to firmly cushion and prevent movement inside the container. Protect the control panel with cardboard.
- d. Seal the shipping container securely.
- e. Mark the shipping container FRAGILE to ensure careful handling.
- f. In any correspondence, refer to the instrument by model number and full serial number.

---

## Power Requirements

The HP 1652B/53B requires a power source of either 115 or 230 Vac  $-22\%$  to  $+10\%$ ; single phase, 48 to 66 Hz; 200 Watts maximum power.

---

## Power Cable







This instrument is provided with a three-wire power cable. When connected to an appropriate AC power outlet, this cable grounds the instrument cabinet. The type of power cable plug shipped with the instrument depends on the country of destination. Refer to Table D-1 for power plugs and HP part numbers for the available plug configurations.

### Warning

---

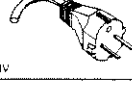
**BEFORE CONNECTING THIS INSTRUMENT**, the protective earth terminal of the instrument must be connected to the protective conductor of the (Mains) power cord. The Mains plug must be inserted in a socket outlet provided with a protective earth contact. The protective action must not be negated by the use of an extension cord (power cable) without a protective conductor (grounding). Grounding one conductor of a two conductor outlet does not provide an instrument ground.

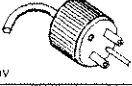
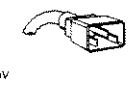
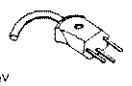
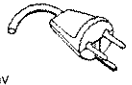
---

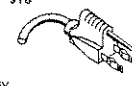
PLUG TYPE	CABLE PART NO.	PLUG DESCRIPTION	LENGTH IN/CM	COLOR	COUNTRY
OPT 900  250V	8120-1351 8120-1703	Straight *BS1363A 90°	90/228 90/228	Gray Mint Gray	United Kingdom, Cyprus, Nigeria, Zimbabwe, Singapore
OPT 901  250V	8120-1369 8120-0696	Straight *NZS5198/ASC 90°	79/200 87/221	Gray Mint Gray	Australia New Zealand
OPT 902  250V	8120-1689 8120-1692 8120-2857	Straight *CEE7-Y11 90° Straight (Shielded)	79/200 79/200 79/200	Mint Gray Mint Gray Coco Brown	East and West Europe, Saudi Arabia, So. Africa, India (Unpolarized in many nations)
OPT 903**  125V	8120-1378 8120-1521 8120-1892	Straight *NEMA5-15P 90° Straight (Medical) UL544	90/228 90/228 96/244	Jade Gray Jade Gray Black	United States, Canada, Mexico, Philippines, Taiwan
OPT 904**  250V	8120-0698	Straight *NEMA6-15P	90/228	Black	United States, Canada
OPT 905  250V	8120-1396 8120-1625	CEE22-V1 (System Cabinet Use) 250V	30/76 96/244	Jade Gray	For interconnecting system components and peripherals. United States and Canada only
OPT 906  250V	8120-2104 8120-2296	Straight *SEV1011 1959-24507 Type 12 90°	79/200 79/200	Mint Gray Mint Gray	Switzerland
OPT 912  220V	8120-2956 8120-2957	Straight *DHCK107 90°	79/200 79/200	Mint Gray Mint Gray	Denmark
OPT 917  250V	8120-4211 8120-4600	Straight SABS164 90°	79/200 79/200	Jade Gray	Republic of South Africa India
OPT 918  100V	8120-4753 8120-4754	Straight Miti 90°	90/230 90/230	Dark Gray	Japan

Rev.11/06/08

ART00619

\*Part number shown for plug is industry identifier for plug only. Number shown for cable is HP part number for complete cable including plug.  
 \*\*These cards are included in the CSA certification approval of the equipment.  
 E=Earth Ground  
 L=Line  
 N=Neutral

Table D-1. Power Cord Configurations

## Removing Yellow Shipping Disk

Your logic analyzer is shipped with a protective yellow shipping disk in the disk drive. Before you can insert the operating system disk you must remove the yellow shipping disk. Press the disk eject button as shown in figure D-1. The yellow shipping disk will pop out part way so you can pull it out of the disk drive.

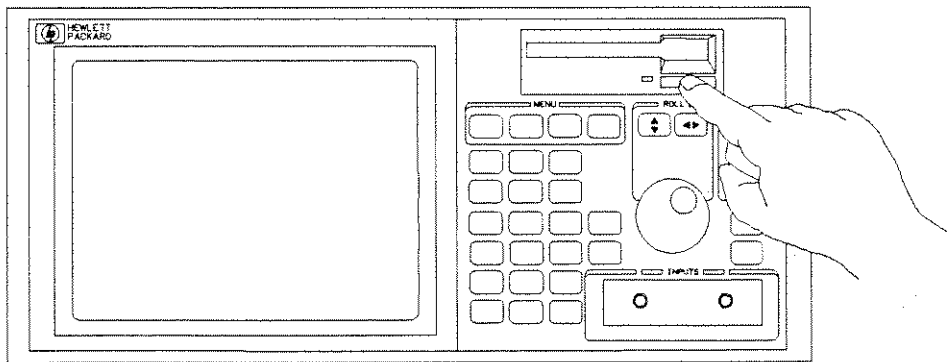

01652E06

**D-1. Removing Yellow Shipping Disk**

---

## Selecting the Line Voltage

The line voltage selector has been factory set to the line voltage used in your country. It is a good idea to check the setting of the line voltage selector so you become familiar with what it looks like. If the setting needs to be changed, follow the procedure in the next paragraph.

---

**Caution** 

You can damage the logic analyzer if the module is not set to the correct position.

---

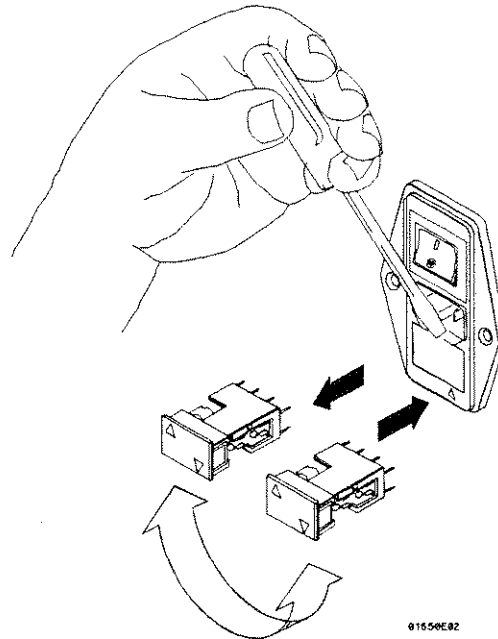

### D-2. Selecting The Line Voltage

You change the proper line voltage by pulling the fuse module out and reinserting it with the proper arrows aligned. To remove the fuse module, carefully pry at the top center of the module (as shown) until you can grasp and pull it out by hand.

---

## Checking for the Correct Fuse

If you find it necessary to check or change fuses, remove the fuse module and look at each fuse for its amperage and voltage. Refer to figure D-3 to locate the 115 V and 230 V fuse locations. To remove the fuse module, carefully pry at the top center of the module (see figure D-2) until you can grasp and pull it out by hand.

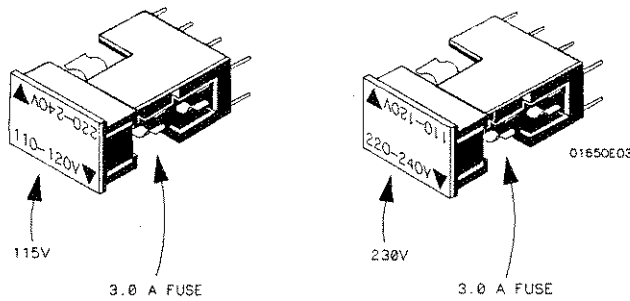

D-3. Checking For The Correct Fuse

---

## Applying Power

When power is applied to the HP 1652B/1653B, a power-up self test will be performed automatically. For information on the power-up self test, refer to Appendix E and Section 3 of the Service Manual.

---

## Loading the Operating System

Before you can operate the instrument, you must load the operating system from the operating system disk. You received two identical operating system disk. You should mark one of them Master and store it in a safe place. Mark the other one Work and use only the work copy. This will provide you with a back-up in case your work copy becomes corrupt.

---

### Caution

To prevent damage to your operating system disk, DO NOT remove the disk from the disk drive while it is running. Only remove it after the indicator light has gone out.

---



---

## Installing the Operating System Disk

To load the logic analyzer's operating system, you must install the disk as shown below before you turn on the power. When the disk snaps into place, the disk eject button pops out and you are ready to turn on the logic analyzer.

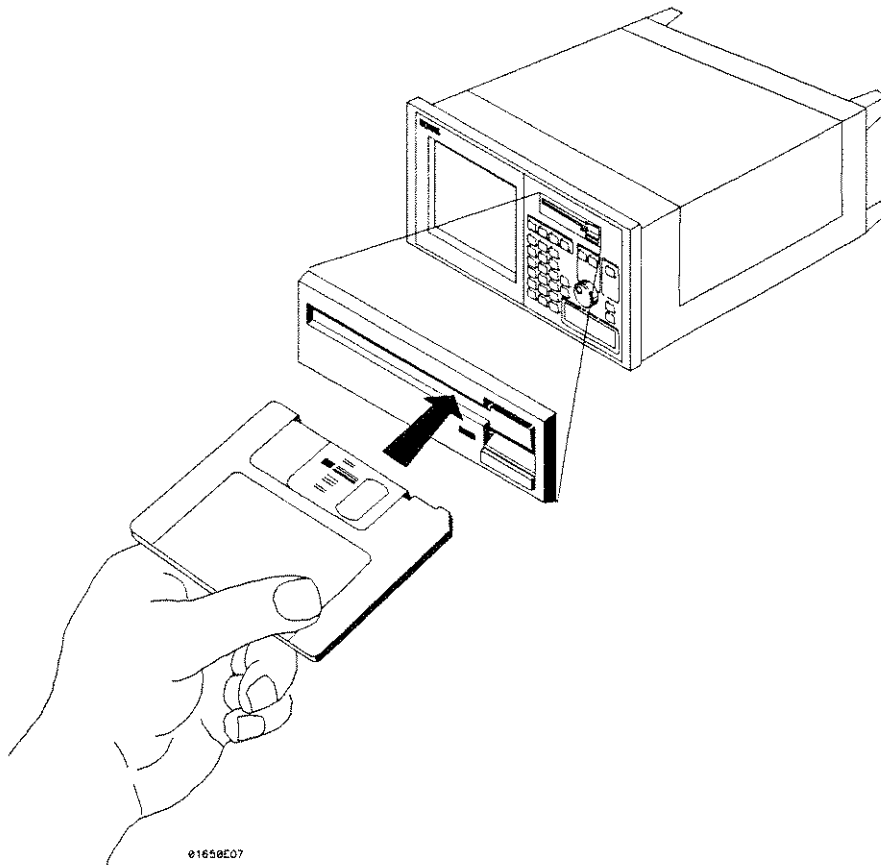

### D-4. Installing The Operating System Disk

The logic analyzer will read the disk and load the operating system. It will also run self-tests before it is ready for you to operate.

## Line Switch

The line switch is located on the rear panel. You turn the instrument on by pressing the 1 on the rocker switch. Make sure the operating system disk is in the disk drive before you turn on the logic analyzer. If you forget the disk, don't worry, you won't harm anything. You will merely have to repeat the turn-on procedure with the disk in the drive.

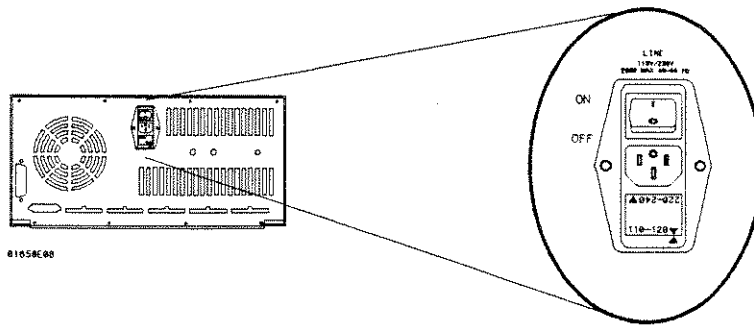

D-5. Line Switch

## Intensity Control

Once you have turned the instrument on, you may want to set the display intensity to a level that's more comfortable for you. You do this by turning the INTENSITY control on the rear panel.

Note



A high intensity level setting may shorten the life of the CRT in your instrument.

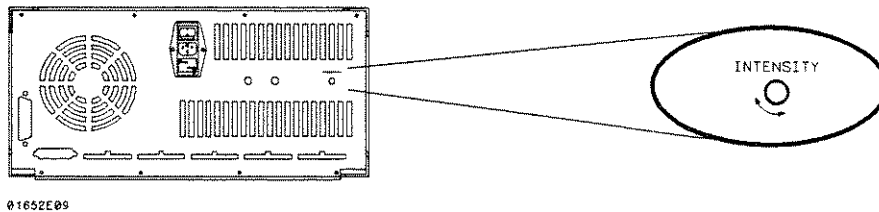

D-6. Intensity Control

---

## **Operator's Maintenance**

The only maintenance you need to do is clean the instrument exterior and periodically check the rear panel for air restrictions.

Use only MILD SOAP and WATER to clean the cabinet and front panel. DO NOT use a harsh soap which will damage the water-base paint finish of the instrument.

---

## **Calibration**

The oscilloscope software calibration is accessed through the oscilloscope Trigger menu. The calibration procedures are performed from the front panel and without need to access internal circuits.

### **Calibration Interval**

Software calibration should be performed if one of the following occurs:

- Oscilloscope board is installed, replaced or repaired.
- Ambient temperature changes more than 10° C.
- 6 months or 1000 hours of operation.

### **Calibration Integrity**

Calibration constants are stored in system memory and not on the Operating System Disk. Therefore, software calibration is not required when a different Operating System Disk is used to boot the instrument on power-up.

---

## Software Calibration Procedures

The following calibration procedures should be performed in their entirety and in the same sequence shown in this procedure. The following test equipment is recommended:

- BNC cable.
- DC Power Supply HP 6114A ( $\pm 0.1$  % accuracy).
- Digital Voltmeter HP 3478A ( $\pm 0.025$  % accuracy).
- BNC (female)-to-dual Banana Adapter.
- BNC -to-mini probe adapter

### Note

An instrument warm-up of 15 minutes is recommended before starting these procedures. To abort any calibration procedure, use the front-panel knob to select the **Cancel** field, then press the **SELECT** key.

---

## Offset Calibration

1. In the **System Configuration** menu turn both State/Timing analyzers Off, and turn the oscilloscope On.
  2. Press the **TRACE/TRIG** key and select the **Calibration** field using the front-panel knob and **SELECT** key.
- 

### Note

Offset calibration should be the default Calibration menu setting. If not, select the Calibration choice field and, when the pop-up appears, select **Offset**.

---

3. Disconnect all signals from the channel 1 and 2 inputs. Select **Start** with the front-panel knob and **SELECT** key. A message will appear on screen to indicate the calibration is in process.
4. When the calibration is complete, the calibration status screen will appear.

## Attenuator Calibration

The attenuator calibration is the only calibration that requires test equipment. If you are not using the recommended equipment listed on the previous page, make sure the substitute equipment meets the critical specifications listed in the *HP 1652B/1653B Service Manual*.

5. Select the Calibration choice field. When the pop-up appears, select **Attenuation**.
6. Connect the test equipment as shown below. The voltmeter monitors the voltage level to the oscilloscope.

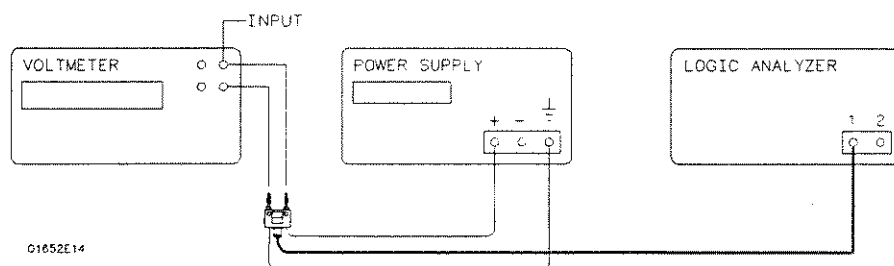

**Figure D-7. Attenuator Calibration Equipment Setup**

7. Select the **Start** field with the front-panel knob and SELECT key. The calibration screen will prompt you to connect the appropriate channel and set the DC voltage as specified.
8. Adjust the power supply to within  $\pm 0.1\%$  of the specified voltage. If the measured voltage displayed on the voltmeter is greater than  $\pm 0.1\%$  from the specified voltage in *step 7*, you will have to compensate the oscilloscope as shown in *step a* below.
  - a. Select the **Voltage** field and enter the measured voltage value, then select **DONE**
9. To proceed with the Attenuator calibration, select the **Continue** field. Repeat steps 8 and 9 for each specified voltage value.
10. When the calibration is complete, the updated calibration status screen will appear.

### Gain Calibration

11. Disconnect all test equipment and all inputs to channel 1 and 2 of the oscilloscope.
12. Select the Calibration choice field. When the pop-up appears, select **Gain**, then select **Start**.
13. When the calibration is complete, the updated calibration status screen will appear.

### Trigger Calibration

14. Make sure all signals are disconnected from the channel 1 and 2 inputs of the oscilloscope.
15. Select the Calibration choice field. When the pop-up appears, select **Trigger level**, then select **Start**.
16. When the calibration is complete, the updated calibration status screen will appear.

### Delay Calibration

17. Select the Calibration choice field. When the pop-up appears, select **Delay**, then select **Start**.
18. Connect a BNC cable from the Probe Compensation output on the rear panel, to the channel 1 input. The instrument will prompt you when you need to switch to channel 2.

#### Note



---

You have the option of using the 10:1 scope probe in place of the recommended 1:1 BNC cable. If you use the scope probe, you will have to use the BNC-to-mini probe adapter supplied with the instrument and set attenuation field in *step 19* to 10:1.

---

19. Set the attenuation field in the calibration screen to the appropriate setting.

20. To proceed with the Delay calibration, select **Continue**.
21. When the calibration is complete, the updated calibration status screen will appear.
22. Calibration is now complete. Select **Done** with the front-panel knob and **SELECT** key to exit the Calibration menu.



---

Do not execute **Set to Default** after calibrating the instrument. Otherwise, your calibration factors will be replaced by default calibration factors.

---





## Operator Self Tests

---

### Introduction

This appendix gives you an overview of the self tests the logic analyzer runs when you turn it on. You can also access the self tests from the I/O menu. This appendix is not intended to provide service information, but to acquaint you with the tests. If service is required, it should be performed by qualified service personnel.

---

### Self Tests

The power-up self test is a set of tests that are automatically performed when you apply power to the logic analyzer. You may perform the self tests individually to have a higher level of confidence that the instrument is operating properly. A message that the instrument has failed a test will appear if any problem is encountered during a test. The individual self tests are listed in the self test menu which is accessed via the I/O menu. The HP 1652B/1653B self tests are on the operating system disk and the disk is required to run the tests.

### Power-up Self Test

The power-up self test is automatically initiated at power-up by the HP 1652B/1653B Logic Analyzers. The revision number of the operating system firmware is given in the upper right of the screen during the power-up self test. As each test is completed, either "passed" or "failed" will be displayed before the test name as shown below.

#### PERFORMING POWER-UP SELF TESTS

passed ROM test  
passed RAM test  
passed Interrupt test  
passed Display test  
passed Keyboard test  
passed Acquisition test  
passed Threshold test  
passed Disk test

#### LOADING SYSTEM FILE

When the power-up self testing is complete, the operating system will be automatically loaded. If the operating system disk is not in the disk drive, the message "SYSTEM DISK NOT FOUND" will be displayed at the bottom of the screen and "NO DISK" will be displayed in front of disk test in place of "passed."

If the "NO DISK" message appears, turn off the instrument, insert the operating system disk into the disk drive, and apply power again.

### **Selectable Self Tests**

The following self tests may be accessed individually in the Self Test menu:

- Analyzer Data Acquisition
- Scope Data Acquisition
- RS-232C
- BNC
- Keyboard
- RAM
- ROM
- Disk Drive
- Cycle through tests

To select a test, place the cursor on the test name and press SELECT. A pop-up menu appears with a description of the test. The self test does not begin until the cursor is placed on Single or Repetitive Test and the SELECT key is pressed.

When the test is complete, either "Passed", "Failed", or "Tested" will be displayed in the Self Test menu in front of the test. These tests are also used as troubleshooting aids. If a test fails, refer to Section 6 of the Service manual for information on the individual tests used for troubleshooting.

## Specifications and Operating Characteristics

### Introduction

This appendix lists the specifications, operating characteristics, and supplemental characteristics of the HP 1652B and HP 1653B Logic Analyzers.

### Logic Analyzer Specifications

**Probes** Minimum Swing: 600 mV peak-to-peak.

Threshold Accuracy:	<u>Voltage Range</u>	<u>Accuracy</u>
	-2.0V to +2.0V	± 150 mV
	-9.9V to -2.1V	± 300 mV
	+2.1V to +9.9V	± 300 mV

**Dynamic Range:** ± 10 volts about the threshold.

**State Mode** **Clock Repetition Rate:** Single phase is 35 MHz maximum (25 MHz on the HP 1653B). With time or state counting, minimum time between states is 60 ns (16.67 MHz). Both mixed and demultiplexed clocking use master-slave clock timing; master clock must follow slave clock by at least 10 ns and precede the next slave clock by ≥ 50 ns.

**Clock Pulse Width:** ≥ 10 ns at threshold.

**Setup Time:** Data must be present prior to clock transition, ≥ 10 ns.

**Hold Time:** Data must be present after rising clock transition; 0 ns.

Data must be present after falling clock transition, 0 ns (HP 1653B); data must be present after falling L clock transition, 0 ns (HP 1652B); data must be present after falling J, K, M, and N clock transition, 1 ns (HP 1652B).

**Timing Mode** Minimum Detectable Glitch: 5 ns wide at the threshold.

---

## Logic Analyzer Operating Characteristics

The following operating characteristics are not specifications, but are typical operating characteristics for the HP 1652B/1653B logic analyzer which are included as additional information for the user.

**Probes** Input RC: 100 K $\Omega$   $\pm$  2% shunted by approximately 8 pF at the probe tip.

**TTL Threshold Preset:** +1.6 volts.

**ECL Threshold Preset:** -1.3 volts.

**Threshold Range:** -9.9 to +9.9 volts in 0.1 volt increments.

**Threshold Setting:** Threshold levels may be defined for pods 1 and 2 individually (HP 1653B). Threshold levels may be defined for pods 1, 2, and 3 on an individual basis and one threshold may be defined for pods 4 and 5 (HP 1652B).

**Minimum Input Overdrive:** 250 mV or 30% of the input amplitude, whichever is greater.

**Maximum Voltage:**  $\pm$  40 volts peak.

**Maximum Power Available Through Cables:** 600 mA @ 5V per cable; 2 amp @ 5V per HP 1652B/1653B.

## Measurement Configurations

Analyzer Configurations:	<u>Analyzer 1</u>	<u>Analyzer 2</u>
Timing	Off	Off
Off	Timing	Timing
State	Off	Off
Off	State	State
Timing	State	State
State	Timing	Timing
State	State	State
Off	Off	Off

**Channel Assignment:** Each group of 16 channels (a pod) can be assigned to Analyzer 1, Analyzer 2, or remain unassigned. The HP 1652B contains 5 pods; the HP 1653B contains 2 pods.

## State Analysis Memory

**Data Acquisition:** 1024 samples/channel.

### Trace Specification

**Clocks:** Five clocks (HP 1652B) or two clocks (HP 1653B) are available and can be used by either one or two state analyzers at any time. Clock edges can be ORed together and operate in single phase, two phase demultiplexing, or two phase mixed mode. Clock edge is selectable as positive, negative, or both edges for each clock.

**Clock Qualifier:** The high or low level of four ORed clocks (HP 1652B) or one clock (HP1653B) can be ANDed with the clock specification. Setup time: 20 ns; hold time: 5 ns.

**Pattern Recognizers:** Each recognizer is the AND combination of bit (0, 1, or X) patterns in each label. Eight pattern recognizers are available when one state analyzer is on. Four are available to each analyzer when two state analyzers are on.

**Range Recognizers:** Recognizes data which is numerically between or on two specified patterns (ANDed combination of zeros and/or ones). One range term is available and is assigned to the first state analyzer turned on. The maximum size is 32 bits and on a maximum of 2 pods.

**Qualifier:** A user-specified term that can be anystate, nostate, a single pattern recognizer, range recognizer, or logical combination of pattern and range recognizers.

**Sequence Levels:** There are eight levels available to determine the sequence of events required for trigger. The trigger term can occur anywhere in the first seven sequence levels.

**Branching:** Each sequence level has a branching qualifier. When satisfied, the analyzer will restart the sequence or branch to another sequence level.

**Occurrence Counter:** Sequence qualifier may be specified to occur up to 65535 times before advancing to the next level.

**Storage Qualification:** Each sequence level has a storage qualifier that specifies the states that are to be stored.

**Enable/Disable:** Defines a window of post-trigger storage. States stored in this window can be qualified.

**Prestore:** Stores two qualified states that precede states that are stored.

### **Tagging**

**State Tagging:** Counts the number of qualified states between each stored state. Measurement can be shown relative to the previous state or relative to trigger. Maximum count is  $4.4 \times 10^{12}$ .

**Time Tagging:** Measures the time between stored states, relative to either the previous state or to the trigger. Maximum time between states is 48 hours.

With tagging on, the acquisition memory is halved; minimum time between states is 60 ns.

### **Symbols**

**Pattern Symbols:** User can define a mnemonic for the specific bit pattern of a label. When data display is SYMBOL, a mnemonic is displayed where the bit pattern occurs. Bit patterns can include zeros, ones, and don't cares.

**Range Symbols:** User can define a mnemonic covering a range of values. Bit pattern for lower and upper limits must be defined as a pattern of zeros and ones. When data display is SYMBOL, values within the specified range are displayed as mnemonic + offset from base of the range.

**Number of Pattern and Range Symbols:** 200 per HP 1652B/1653B.

Symbols can be down-loaded over RS-232C and HP-IB.

### **State Compare Mode**

Performs post-processing bit-by-bit comparison of the acquired state data and compare data image.

**Compare Image:** Created by copying a state acquisition into the compare image buffer. Allows editing of any bit in the compare image to a zero, one, or don't care.

**Compare Image Boundaries:** Each channel (column) in the compare image can be enabled or disabled via bit masks in the compare image. Upper and lower ranges of states (rows) in the compare image can be specified. Any data bits that do not fall within the enabled channels and the specified range are not compared.

**Stop Measurement:** Repetitive acquisitions may be halted when the comparison between the current state acquisition and the current compare image is equal or not equal.

**Displays:** Compare Listing display shows the compare image and bit masks; Difference Listing display highlights differences between the current state acquisition and the current compare image.

#### **State X-Y Chart Display**

Plots the value of the specified label (on the y-axis) versus states or another label (on the x-axis). Both axes can be scaled by the user.

**Markers:** Correlated to state listing, state compare, and state waveform displays. Available as pattern, time, or statistics (with time counting on), and states (with state counting on).

**Accumulate:** Chart display is not erased between successive acquisitions.

#### **State Waveform Display**

Displays a state acquisition in a waveform format.

**States/div:** 1 to 104 states.

**Delay:** 0 to 1024 states.

**Accumulate:** Waveform display is not erased between successive acquisitions.

**Overlay Mode:** Multiple channels can be displayed on one waveform display line. Primary use is to view a summary of bus activity.

**Maximum Number of Displayed Waveforms:** 24.

**Markers:** Correlated to state listing, state compare, and X-Y chart displays. Available as pattern, time, or statistics (with time counting on), and states (with state counting on).



## **Timing Analysis Transitional Timing Mode**

Sample is stored in acquisition memory only when the data changes. A time tag stored with each sample allows reconstruction of a waveform display. Time covered by a full memory acquisition varies with the number of pattern changes in the data.

**Sample Period:** 10 ns.

**Maximum Time Covered By Data:** 5000 seconds.

**Minimum Time Covered by Data:** 10.24  $\mu$ s.

### **Glitch Capture Mode**

Data sample and glitch information is stored every sample period.

**Sample Period:** 20 ns to 50 ms in a 1-2-5 sequence dependent on sec/div and delay settings.

**Memory Depth:** 512 samples/channel.

**Time Covered by Data:** Sample period X 512

### **Waveform Display**

**Sec/div:** 10 ns to 100 s; 0.01% resolution.

**Screen Delay:** -2500 s to 2500 s; presence of data is dependent on the number of transitions in data between trigger and trigger plus delay (transitional timing).

**Accumulate:** Waveform display is not erased between successive acquisitions.

**Hardware Delay:** 20 ns to 10 ms.

**Overlay Mode:** Multiple channels can be displayed on one waveform display line. Primary use is to view a summary of bus activity.

**Maximum Number Of Displayed Waveforms:** 24

### **Time Interval Accuracy**

**Channel to Channel Skew:** 4 ns typical.

**Sample Period Accuracy:** 0.01% of sample period.

**Time Interval Accuracy:**  $\pm$  (sample period + channel-to-channel skew + 0.01% of time interval reading).

### **Trigger Specification**

**Asynchronous Pattern:** Trigger on an asynchronous pattern less than or greater than a specified duration. Pattern is the logical AND of a specified low, high, or don't care for each assigned channel. If pattern is valid but duration is invalid, there is a 20 ns reset time before looking for patterns again.

**Greater Than Duration:** Minimum duration is 30 ns to 10 ms with 10 ns or 0.01% resolution, whichever is greater. Accuracy is +0 ns to -20 ns. Trigger occurs at pattern + duration.

**Less Than Duration:** Maximum duration is 40 ns to 10 ms with 10 ns or 0.01% resolution, whichever is greater. Pattern must be valid for at least 20 ns. Accuracy is +20 ns to -0 ns. Trigger occurs at the end of the pattern.

**Glitch/Edge Triggering:** Trigger on a glitch or edge following a valid duration of an asynchronous pattern while the pattern is still present. Edge can be specified as rising, falling, or either. Less than duration forces glitch and edge triggering off.

## **Measurement and Display Functions**

### **Autoscale (Timing Analyzer Only)**

Autoscale searches for and displays channels with activity on the pods assigned to the timing analyzer.

### **Acquisition Specifications**

**Arming:** Each analyzer can be armed by the run key, the other analyzer, or the external trigger in port.

**Trace Mode:** Single mode acquires data once per trace specification; repetitive mode repeats single mode acquisitions until stop is pressed or until the time interval between two specified patterns is less than or greater than a specified value, or within or not within a specified range. There is only one trace mode when two analyzers are on.

### **Labels**

Channels may be grouped together and given a six character name. Up to 20 labels in each analyzer may be assigned with up to 32 channels per label. Primary use is for naming groups of channels such as address, data, and control busses.

### **Indicators**

**Activity Indicators:** Provided in the Configuration, State Format, and Timing Format menus for identifying high, low, or changing states on the inputs.

**Markers:** Two markers (X and 0) are shown as dashed lines on the display.

**Trigger:** Displayed as a vertical dashed line in the timing waveform display and as line 0 in the state listing display.

### **Marker Functions**

**Time Interval:** The X and 0 markers measure the time interval between one point on a timing waveform and trigger, two points on the same timing waveform, two points on different waveforms, or two states (time tagging on).

**Delta States (State Analyzer Only):** The X and 0 markers measure the number of tagged states between one state and trigger, or between two states.

**Patterns:** The X and 0 markers can be used to locate the nth occurrence of a specified pattern before or after trigger, or after the beginning of data. The 0 marker can also find the nth occurrence of a pattern before or after the X marker.

**Statistics:** X to 0 marker statistics are calculated for repetitive acquisitions. Patterns must be specified for both markers and statistics are kept only when both patterns can be found in an acquisition. Statistics are minimum X to 0 time, maximum X to 0 time, average X to 0 time, and ratio of valid runs to total runs.

#### **Run/Stop Functions**

**Run:** Starts acquisition of data in a specified trace mode.

**Stop:** In single trace mode or the first run of a repetitive acquisition, STOP halts the acquisition and displays the current acquisition data. For subsequent runs in repetitive mode, STOP halts the acquisition of data and does not change current display.

#### **Data Display/Entry**

**Display Modes:** State listing; timing waveforms; interleaved, time-correlated listing of two state analyzers (time tagging on); time-correlated state listing and timing waveform display (state listing in upper half, timing waveform in lower half, and time tagging on).

**Timing Waveform:** Pattern readout of timing waveforms at X or 0 marker.

**Bases:** Binary, Octal, Decimal, Hexadecimal, ASCII (display only), and User-defined symbols.

---

## Oscilloscope Specifications

The following specifications are the performance standards or limits against which the oscilloscope in the HP 1652B/1653B is tested.

**Vertical** Bandwidth (-3 dB): dc to 100 MHz (single shot).

DC Gain Accuracy:  $\pm 3\%$  of full scale.

DC Offset Accuracy:  $\pm (2 \text{ mV} + 2\% \text{ of the channel offset} + 2.5\% \text{ of full scale})$ .

Voltage Measurement Accuracy (DC): (Gain accuracy + ADC resolution + Offset accuracy).

**Horizontal** Time Interval Measurement Accuracy:  $\pm (2\% \text{ X s/div} + 0.01\% \text{ X delta-t} + 500 \text{ ps})$ .

**Trigger** Sensitivity: 10% of full screen.

---

## Oscilloscope Operating Characteristics

The following operating characteristics are not specifications, but are typical operating characteristics for the oscilloscope in the HP 1652B/1653B. These are included as additional information for the user.

**Vertical (at BNC)** Transition Time (10% to 90%):  $\leq 3.5 \text{ ns}$ .

Number of Channels: 2.

Vertical Sensitivity Range: 15 mV/div to 10 V/div (1:1 probe).

Vertical Sensitivity Resolution: Adjustable 2 digit resolution.

Maximum Sample Rate: 400 MSamples/second.

Analog-to-Digital Conversion: 6 bit real-time.

**Analog-to-Digital Resolution:**  $\pm 1.6\%$  of full scale.

**Waveform Record Length:** 2048 points.

**Input R:**  $1\text{ M}\Omega \pm 1\%$  or  $50\ \Omega \pm 1\%$ .

**Input C:** Approximately 7 pF.

**Input Coupling:** dc.

**Maximum Safe Input Voltage:**

1 M $\Omega$ input,	$\pm 250\text{ V}$ [dc + peak ac (< 10 kHz)]
50 $\Omega$ input,	$\pm 5\text{ V RMS}$

**DC Offset Range (1:1 Probe):**

<u>Vertical Sensitivity</u>	<u>Available Offset</u>
-----------------------------	-------------------------

$\leq 50\text{ mV/div}$	$\pm 2.0\text{ V}$
-------------------------	--------------------

100 mV/div - 200 mV/div	$\pm 10\text{ V}$
-------------------------	-------------------

500 mV/div - 1 V/div	$\pm 50\text{ V}$
----------------------	-------------------

$\geq 2\text{ V/div}$	$\pm 125\text{ V}$
-----------------------	--------------------

$\pm 5\text{ V}$  max if input impedance is at 50  $\Omega$ .

**DC Offset Resolution (1:1 Probe)**

<u>Vertical Sensitivity</u>	<u>Resolution</u>
-----------------------------	-------------------

$\leq 50\text{ mV/div}$	200 $\mu\text{V}$
-------------------------	-------------------

100 mV/div - 200 mV/div	1 mV
-------------------------	------

500 mV/div - 1 V/div	5 mV
----------------------	------

$\geq 2\text{ V/div}$	25 mV or 4 digits of resolution, whichever is greater.
-----------------------	--

**Probe Factors:** Any integer ratio from 1:1 to 1000:1.

**Channel Isolation:**

40 dB: dc to 50 MHz.

30 dB: 50 MHz to 100 MHz (with channels at equal sensitivity).

**Horizontal** Timebase Range: 5 ns/div to 5 s/div.

**Timebase Resolution:**

<u>Time/Division Setting</u>	<u>Resolution</u>
$t < 10 \text{ ns/div}$	100 ps
$t \geq 10 \text{ ns/div}$	adjustable with 3-digit resolution

**Delay Pre-trigger Range:** 5 X (s/div) @  $5 \text{ ns} \leq \text{s/div} \leq 500 \text{ ns}$   
 $2.5 \mu\text{s X (s/div) @ } 500 \text{ ns} \leq \text{s/div} \leq 5 \text{ s}$

**Delay Post-trigger Range:**

<u>Time/Division Setting</u>	<u>Available Delay</u>
50 ms - 5 s/div	40 X (s/div)
100 $\mu\text{s}$ - 20 ms/div	1 s
5 ns - 50 $\mu\text{s/div}$	10,000 X (s/div)

**Trigger** Triggering on either input channel, rising or falling edge.

**Trigger Level Range:** dc Offset  $\pm 5$  divisions.

**Trigger Level Resolution (1:1 Probe):**

<u>Trigger Level</u>	<u>Resolution</u>
$\leq 50 \text{ mV/div}$	400 $\mu\text{V}$
100 mV/div - 200 mV/div	2 mV
500 mV/div - 1 V/div	10 mV
$\geq 2 \text{ V/div}$	50 mV

**Arming:** Armed by the Run key, external BNC low input, or by Analyzer 1 or 2.

**Trigger Modes**

**Immediate:** Triggers immediately after the arming condition is met.

**Edge:** Triggers on the rising or falling edge from channel 1 or 2.

**Auto-Trigger:** Self-triggers if no trigger condition is found within approximately 1 second after arming.

**Trigger Out:** Arms Analyzer 1 or 2, or triggers the rear panel BNC.

**Waveform Display** **Display Formats:** 1 to 8 oscilloscope waveforms can be displayed.

**Display Resolution:** 500 points horizontally, 240 points vertical.

#### **Display Modes**

**Normal:** New acquisitions replace old acquisitions on screen.

**Accumulate:** New acquisitions are added to the screen and displayed with previous acquisitions until a parameter is changed and a new acquisition is made.

**Average:** New acquisitions are averaged with older acquisitions and displayed. Maximum number of averages is 256.

**Overlay:** Channel 1 and 2 can be overlaid in the same display area.

**Connect-the-dots:** Provides a display of the sample points connected by straight lines.

**Waveform Reconstruction:** A reconstruction filter fills in missing data points when timebase is  $\leq 100$  ns/Div or when timebase is reduced to a setting where fewer than 500 samples are on screen.

**Waveform Math:** Display capability of A-B and A + B functions is provided.

**Mixed Mode:** Oscilloscope plus logic analyzer displays on the same screen.



## Measurement Aids

**Time Markers:** Two vertical markers labeled X and O. Voltage levels are displayed for each marker. Time interval measurements can be made between any two events.

**Automatic Search:** Searches for a specified absolute or percentage voltage level at a positive or negative edge, count adjustable from 1 to 1024.

**Auto Search Statistics:** Mean, maximum, and minimum values for elapsed time from X to O markers for multiple runs. Number of valid runs and total number of runs displayed.

**Trigger Level Marker:** Horizontal trigger level marker displayed in Trace/Trigger menu only.

**Automatic Measurements:** The following pulse parameter measurements can be performed automatically:

- Frequency
- Period
- V p-p
- Rise time
- Fall time
- Preshoot
- Overshoot
- + pulse width
- pulse width

**Grid:** May be turned on or off.

## Setup Aids

**Autoscale:** Auto sets the vertical and horizontal ranges, offset, and trigger levels to display the input signals. Requires an amplitude above 10 mV peak, and a frequency between 50 Hz and 100 MHz.

**Preset:** Scales the vertical range, offset, and trigger level to predetermined values for displaying ECL or TTL waveforms.

**Calibration:** Attenuation, offset, gain, trigger, and delay set to defaults.

**Probe Compensation Source:** External BNC supplies square wave approximately -400 mV to -900 mV at approximately 1.25 kHz.

---

## **Interactive Measurements**

**Acquisition** . Oscilloscope, timing, and state can occur simultaneously or in series.

**Mixed Displays** Timing channels and oscilloscope channels can be displayed on the same screen. Multiple state machine listings can be displayed with time tags on the same screen. Timing channels can be displayed with a state listing with Time Tags turned on. State listings with time tags, timing channels, and oscilloscope channels can be displayed on the same screen.

**Time Correlation** All modules are time correlated with the exception of when the oscilloscope is being armed by the logic analyzer, and when the oscilloscope is not in trigger immediate mode.

**Time Interval  
Accuracy  
Between Modules** Equals the sum of channel to channel time interval accuracies of each machine used for a measurement.

---

## General Characteristics

The following general characteristics for the HP 1652B/1653B include the environment operating conditions, shipping weights, and instrument dimensions.

### Operating Environment Temperature

#### Instrument:

**Operating:** 0°C to +55°C (32°F to +131°F)

**Non-operating:** -40°C to +70°C (-40°F to +158°F)

**Probes and Cables:** 0°C to 65°C (+32°F to +149°F)

**Disk Media:** 10°C to 50°C (+50°F to +149°F).

#### Humidity:

##### Instrument:

**Operating:** Up to 95% relative humidity (non-condensing) at +40°C (+104°F)

**Non-operating:** Up to 90% relative humidity at +65°C (+149°F)

**Disk Media:** 8% to 80% relative humidity at +40°C (+104°F)

#### Altitude

**Operating:** Up to 4600 meters (15,000 ft)

**Non-operating:** Up to 15,300 meters (50,000 ft)

#### Vibration

**Operating:** Random vibration 5-500 Hz, 10 minutes per axis, 0.3 g (rms)

**Non-operating:** Random vibration 5-500 Hz, 10 minutes per axis, 2.41 g (rms);

Resonant search 5-500 Hz swept sine, 1 Octave/minute sweep rate, 0.75 g (0-peak), 5 minute resonant dwell at 4 resonances per axis.

**Power Requirements** 115/230 Vac, -25% to +15%, 48-66 Hz, 200 W max.

**Weight** 10.0 kg (22 lbs) net; 18.2 kg (40 lbs) shipping.

**Dimensions** Refer to the outline drawing below.

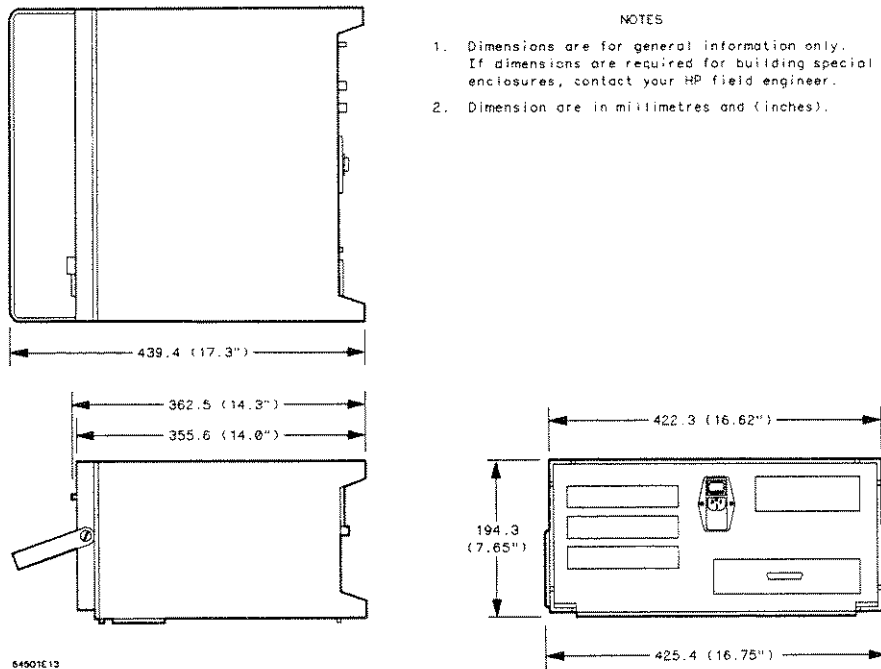

Figure F-1. HP 1652B/1653B Dimensions



restart 10-14  
 branching  
   multiple levels 10-17  
   secondary 10-15  
 branching qualifier 10-8

## C

cables for printer 7-3  
 Calibration 24-1, D-1  
 Cancel field 5-4  
 Changing Alpha Entries 3-15  
 Channel Menu 23-1  
 Channel Menu Fields  
   Impedance 23-5  
   Input 23-1  
   Offset 23-3  
   Preset 23-5  
   Probe 23-4  
   V/Div 23-2  
 CHS Key 3-4  
 Clear Entry Key 3-3  
 clock  
   demultiplex 9-10  
   master 9-10  
   mixed 9-11  
   normal 9-9  
   period (state) 9-12  
   slave 9-10  
   state 9-7  
 Closing Pop-up Menus 3-9  
 Compare Image 12-3  
   Bit Editing of the 12-4  
   Creating a 12-3  
   Masking Channels in the 12-5  
   Saving 12-8  
 Compare Listing Display 12-2  
 Compare Range 12-6  
   Specifying a 12-6  
 Compensation Signal 2-7

Configuration Capabilities  
   HP 1652B capabilities 1-2  
   HP 1653B capabilities 1-3  
 Connect dots Field 25-31  
 Connecting  
   analyzer to target system 2-8  
   Grabbers to probes 2-12  
   Grabbers to test points 2-12  
   Labels to pods, probes, cables 2-13  
   Other HP Printers 7-9  
   Pods to probe cables 2-10  
   probe cables to analyzer 2-9  
 Continue field 5-4  
 Copy 5-7, 6-1  
 Copying a File 6-15  
 count 10-18  
   States 10-20  
   Time 10-18  
 Cursor 3-7

## D

data  
   bits 5-15  
   time-correlating 21-11, 27-12  
 Delay 23-17  
   from Trigger (State) 14-5  
 Delay (timing) 19-9  
 Deleting Waveforms (State) 14-4  
 Demultiplex (clock) 9-10  
 Difference Listing  
   Locating Mismatches in 12-8  
 Difference Listing Display 12-2  
 disk  
   drive operations 6-1  
   format (LIF) 6-7  
   Installing a Blank Disk 6-6  
   operations 5-3  
 Disk Drive 3-5  
 Disk Eject Button 3-5







Marker Measurements	25-12	State Chart	8-9 - 8-10
markers		State Compare	8-6
Pattern (state)	11-4	State Format	8-2
Pattern (timing)	19-5	State Listing	8-5
Statistics (state)	11-6	State Trace	8-3
Statistics (timing)	19-6	State Waveform	8-7 - 8-8
Time (state)	11-6	timing analyzer	16-1
Time (timing)	19-4	Timing Format	16-2
Timing Waveforms menu	19-3	Timing Trace	16-3
X and O	20-10	Timing Waveform	16-4
Markers Field for Scope		Trigger Menu	22-3
Sample Period Display	25-14	Waveform Selection	22-5
Search	25-16	Waveforms Menu	22-4
Specify Search Markers	25-16	menus	
Statistics	25-23	Disk Operations	5-3, 6-1
Time	25-14	I/O	5-1
X-O Pattern from start	25-22	I/O Port Configuration	5-12
master clock	9-10	Specify Symbols (state)	9-7, 9-12
measurement example		Specify Symbols (timing)	17-7
state analyzer	15-1	State Chart	13-1
timing analyzer	20-1	State Compare	12-1
timing/state analyzer	21-1	State Format Specification	9-1
measurements		State Listing	11-1
microprocessor	A-1	State Trace	10-1
memory		State Waveform	14-1
acquisition	18-4 - 18-5	State Waveforms	14-1
menu fields		Timing Format Specification	17-1
Specify Symbols (state)	9-13	Timing Trace Specification	18-1
Specify Symbols (timing)	17-8	Timing Waveforms	19-1
st/Div (states-per-division)	14-4	Microprocessor Specific	
State Format Specification	9-3	Measurements	A-1
State Listing menu	11-3	Microprocessors Supported	A-3
State Trace menu	10-2	mixed clocks	9-11
Timing Format Specification	17-3	Mixed Mode Displays	26-1
Timing Trace Specification	18-2	Arming the Scope	26-4
Timing Waveforms menu	19-3	Displaying Timing Waveforms	26-5
Menu Keys	3-2	State/State	26-3
menu maps		State/Timing/Scope Mixed	
Channel Menu	22-2	Mode Display	26-8
Specify Markers	22-5	Time-Related Displays	26-9
state analyzer	8-1	Timing/Scope	26-4



Probe Inputs for Scope	2-7
Probe Pod Assemblies	2-4
Probes	2-5
Probing Options	
General Purpose Probing	2-3
HP 10269C General Purpose	
Probe Interface	2-2
HP 10320C User-Definable	
Interface	2-1
Termination Adapter	2-3
Probing System for Analyzer	
description	2-4
Grabbers	2-6
Maximum Probe Input Voltage	2-8
Pod Grounding	2-5
Probe Cable	2-6
Probe Grounding	2-6
Probe Pod Assemblies	2-4
Probes	2-5
Signal Line Loading	2-8
Probing System for Scope	
Compensation Signal Outputs	2-7
description	2-7
External Trigger Inputs	2-7
Maximum Probe Input Voltage	2-8
Probe Inputs	2-7
protocol	5-14
Purge	5-10, 6-1
Purging a File	6-14

## Q

Qualifier Field (state)	10-23
qualifier	10-2
branching	10-8
fields	10-22
storage	10-8

## R

range	
recognizers	10-2
ranges	10-24
Rear-Panel Controls and Connectors	
External Trigger BNCs	3-6
Fan	3-7
HP-IB Interface Connector	3-7
Intensity Control	3-6
Line Power Module	3-6
Pod Cable Connectors	3-6
Probe Compensation Signal	3-7
RS-232C Interface Connector	3-6
Recommended Protocol (RS-232C)	7-6
Rename	5-9, 6-1
repetitive	
trace mode (state)	10-13
trace mode (timing)	18-3
Repetitive Run Mode	24-7
Replacing Waveforms (State)	14-3
Returning to system configuration	3-8
Roll Data	3-16
Roll Keys	3-4
RS-232C	
default configuration	7-6
printer cables	7-3
recommended protocol	7-6
setting for HP printers	7-5
setting for non-HP printers	7-5
Run Key	3-3
Run Mode Field	24-7
Repetitive Mode Run	24-7
Single Mode Run	24-7

## S

sample period	19-3	An Overview	8-1
Scope		menu maps	8-1
Introduction	22-1	State Chart menu	13-1
Scope Field	25-1	Accessing the	13-1
Scope Menus Overview	22-6	state clock	9-7
Scope On/Off Field	4-5	State Compare menu	
Select Key	3-4	Accessing the	12-2
Selecting a Waveform (State)	14-2	State Format Specification menu	9-1
Selecting an Address (HPIB)	5-13	Accessing the	9-1
Selecting Fields	3-9	fields	9-3
Selecting Menus	3-7	State Listing menu	11-1
Selecting Options	3-10	Accessing the	11-2
self test	5-18	fields	11-3
Self Tests-powerup	E-1	state tagging	10-20
sequence levels	10-6	State Trace menu	10-1
Delete Level	10-7	Accessing the	10-2
Insert Level	10-7	fields	10-2
Reading the Display	10-11	State Waveforms menu	14-1
Signal Line Loading	2-8	Accessing the	14-1
single		State/State Mixed Mode Display	26-3
trace mode (state)	10-13	Statistics	25-23
trace mode (timing)	18-3	Stop bits	5-15
Single Run Mode	24-7	Stop Key	3-3
slave clock	9-10	Stop Measurement	
Slope Field	24-6	state	11-5
Source Field	24-4	Stop Measurement (timing)	19-5
Specifications	F-1	storage macro	10-9
Specify Search Markers		storage qualifier	10-8
Greater than	25-20	Store	5-5, 6-1
In/Not IN Range	25-21	Store exception to disk	
Less than	25-19	state	11-5
Type	25-17	State Compare	12-7
X-O Marker set on	25-17	timing	19-6
Specifying Edges	3-19	Storing to a Disk	6-9
Specifying Patterns	3-18	supported printers	7-1
st/Div (states-per-division)	14-1, 14-4	Switching Between Analyzer	
state analyzer	8-1	and Scope	3-8
		symbols	17-7
		base	9-14, 17-8
		label	9-13, 17-8
		name	9-15, 17-10



Toggle Fields	3-11
User-Definable Interface	2-1

## V

V/Div Field	23-2
view size	
symbol	17-10

## W

Waveform Selection	23-6
Insert/Delete	23-9
Math	23-12
Modify	23-10
Overlay	23-11
Turning them ON/OFF	23-8
Waveforms Menu	
Auto-Measure Field	25-1
Connect dots Field	25-31
Description	25-1
Display Field	25-29
Marker Measurements	25-12
Markers Field	25-13
Scope Field	25-1
Search Marker Measurement	
Example	25-24

## X

X and O markers	
State Chart	13-5
State Waveform	14-5
Timing Waveforms	20-10
X to Trig(ger)	19-4